

EDAC NEWS

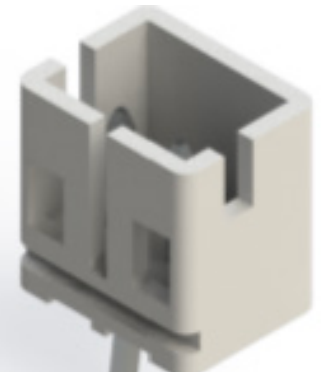

140 SERIES | INLINE CONNECTORS

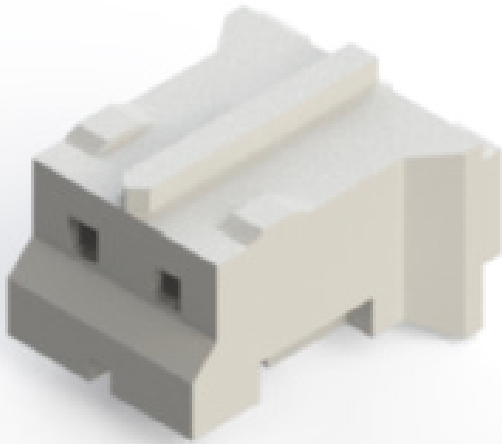

140 Series Inline Plug and Socket Connectors

EDAC's 140 series inline plug and socket connectors are an economical wire-to-board connection. The simple crimp and poke contacts can crimp to wires and then insert into the housing. The male shrouded header mounts to boards, either through-hole or surface mount, and is available in vertical or right-angle configurations. Users can connect the two for a high continuity connection. The internal latches provide for excellent shock and vibration resistance. A pitch of 2mm conserves valuable board space and facilitates high-density connections. The space-saving design facilitates proper fit to new applications or provides for an easy drop-in replacement.

Features

- Pitch 0.079" 2.0 mm
- Low profile 0.185" 4.7mm width
- 0.240" 6.10 mm height
- Through hole or SMT terminations
- Top and side entry options
- Crimp and poke cable mount contact
- Accepts wire gauges AWG#30 to AWG#24
- Operating temperature range -40C to +105C
- Designed for high density connections to PCB
- Current rating: 2 A per contact
- Voltage rating: 100 VAC
- Available in 2-16 positions

Applications

- **Industrial:** Process control, robotics
- **Energy:** Electrical Panels
- **Consumer:** Common for display connections
- **Appliance:** Common for board to motor or control valves
- **Medical:** Common for display connections, fans
- **Security Systems:** Feeds from camera back to control box

TOP ENTRY

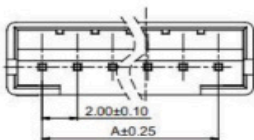

CAVITY NO.

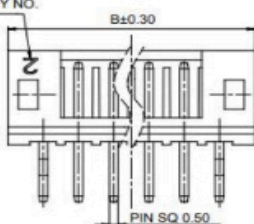

3P~16P

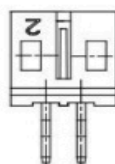

2P

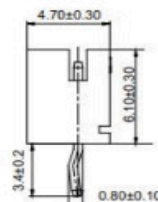

140 SERIES

Wire to Board Connectors



Features:

- 0.079" (2.00mm) contact spacing
- For use with PC board thickness: 0.047" (1.2mm) ~ 0.062" (1.6mm)
- Low profile insulator body, 0.185" (4.7mm) width 0.240" (6.10mm) Height
- Contact termination options include: P.C. tail, surface mount
- Top entry or side entry configurations
- Board retention contacts available
- Designed for high-density connection of internal wires to PCB

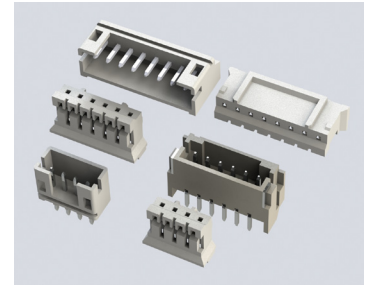

Specifications:

Insulator Material	PA66, UL94V-0, Natural Color	
Contact Material	Brass (For Male Header)	Phosphor Bronze (For Female Contact)
Contact Plating	Tin Plating (For Male Header)	Tin Plating, Copper Underplating (For Female Contact)
Current Rating	2 amps	
Voltage Rating	100 V	
Contact Resistance	Initial: 10 milliohms maximum	
Dielectric Withstanding Voltage	800 V AC rms	
Insulation Resistance	1000 megaohms minimum	
Operating Temperature	-40°C to +105°C	
Applicable Wire	AWG #30~#24	

Through-Hole Type Header:

TOP ENTRY

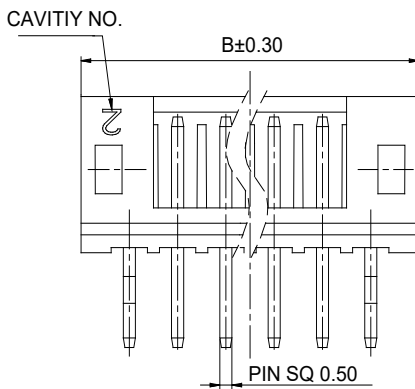
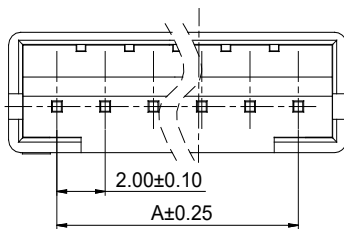

3P~16P

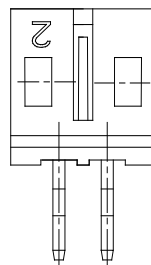

2P

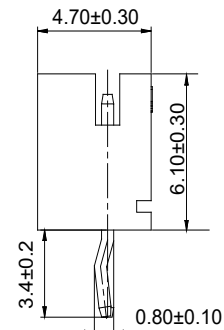

140 SERIES



Wire to Board Connectors

SIDE ENTRY

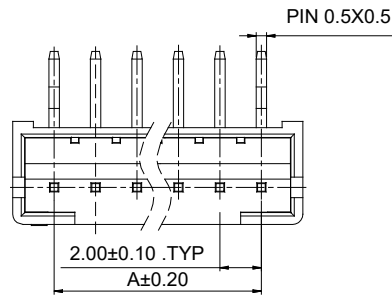

CAVITY NO.

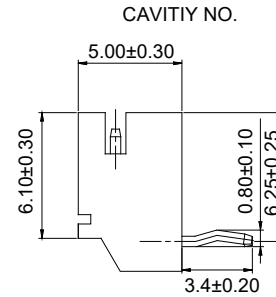
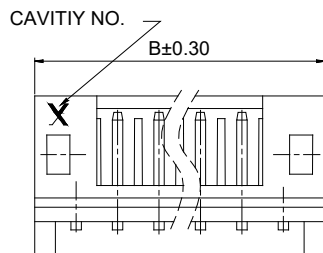

No. of Circuits	Top Entry	Side Entry		
	EDAC P/N	EDAC P/N	Dim A	Dim B
2	140-502-415-001	140-502-415-000	2.00	6.00
3	140-503-415-001	140-503-415-000	4.00	8.00
4	140-504-415-001	140-504-415-000	6.00	10.00
5	140-505-415-001	140-505-415-000	8.00	12.00
6	140-506-415-001	140-506-415-000	10.00	14.00
7	140-507-415-001	140-507-415-000	12.00	16.00
8	140-508-415-001	140-508-415-000	14.00	18.00
9	140-509-415-001	140-509-415-000	16.00	20.00
10	140-510-415-001	140-510-415-000	18.00	22.00
11	140-511-415-001	140-511-415-000	20.00	24.00
12	140-512-415-001	140-512-415-000	22.00	26.00

140 SERIES



Wire to Board Connectors

Through-Hole Header:

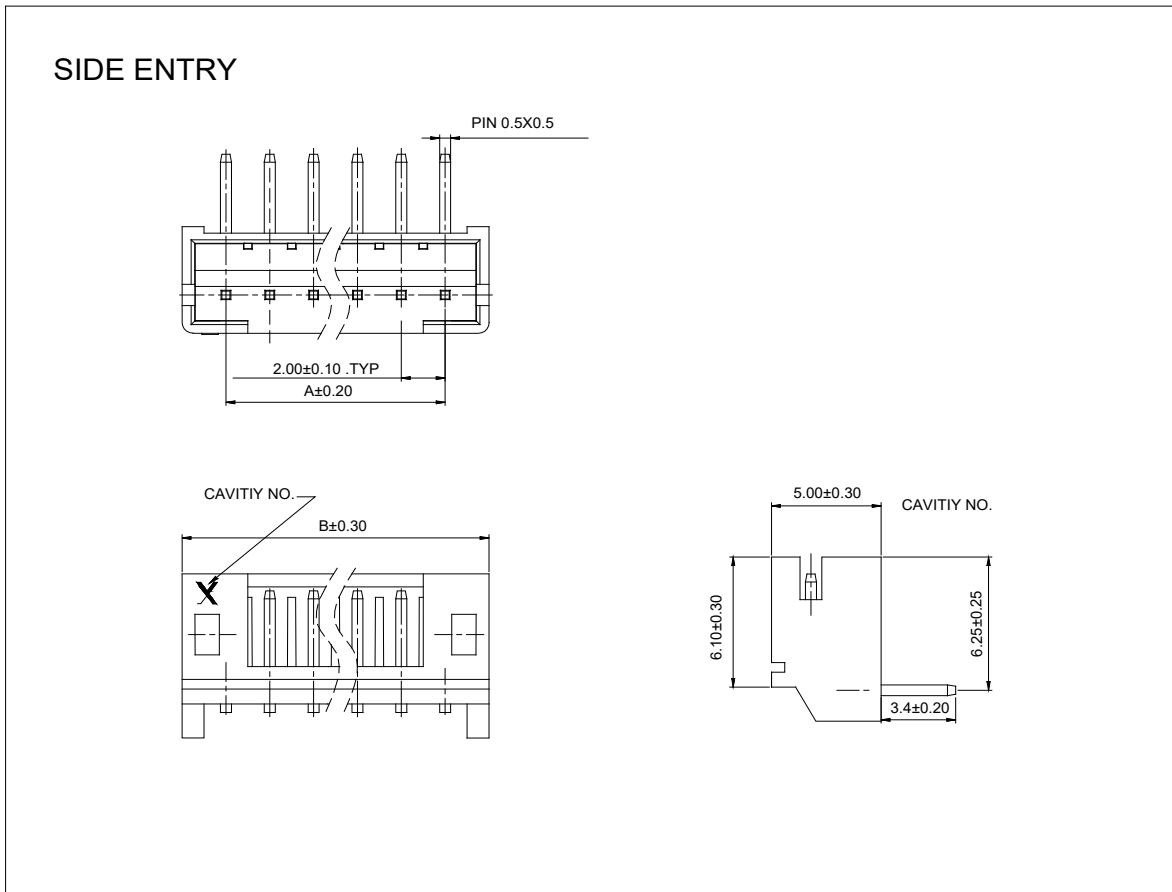
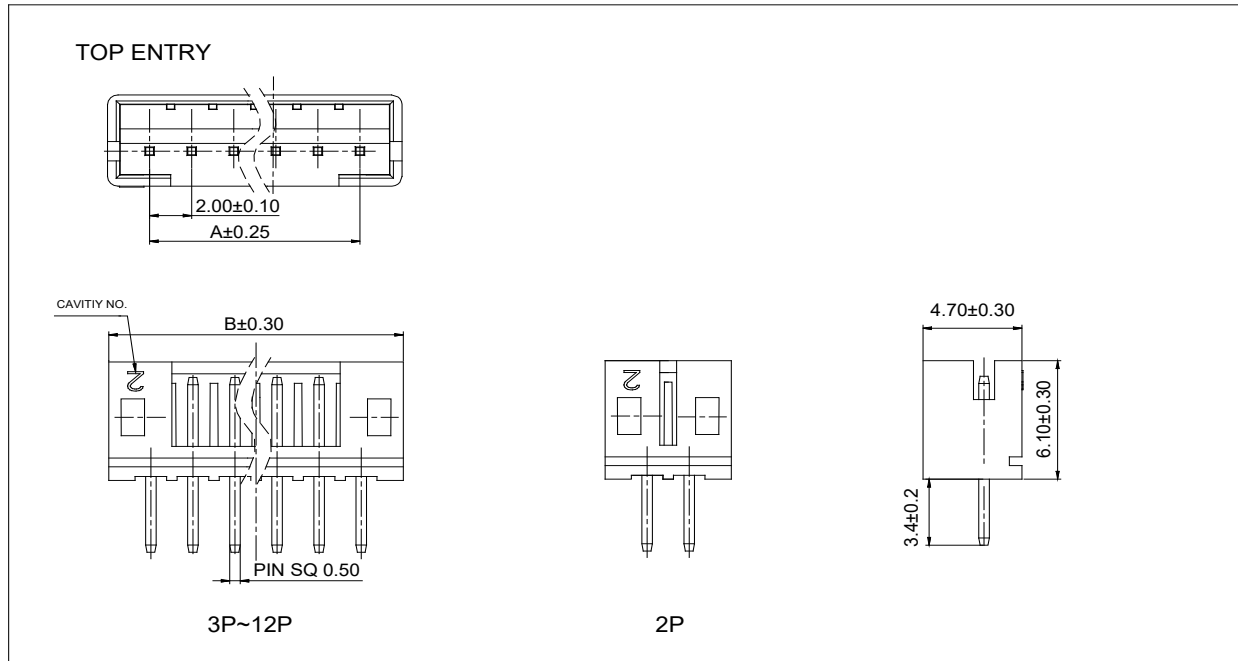

140 SERIES



Wire to Board Connectors

Through-Hole Header:

No. of Circuits	Top Entry	Side Entry		
	EDAC P/N	EDAC P/N	Dim A	Dim B
2	140-502-415-101	140-502-415-100	2.00	6.00
3	140-503-415-101	140-503-415-100	4.00	8.00
4	140-504-415-101	140-504-415-100	6.00	10.00
5	140-505-415-101	140-505-415-100	8.00	12.00
6	140-506-415-101	140-506-415-100	10.00	14.00
7	140-507-415-101	140-507-415-100	12.00	16.00
8	140-508-415-101	140-508-415-100	14.00	18.00
9	140-509-415-101	140-509-415-100	16.00	20.00
10	140-510-415-101	140-510-415-100	18.00	22.00
11	140-511-415-101	140-511-415-100	20.00	24.00
12	140-512-415-101	140-512-415-100	22.00	26.00

SMT Header:

TOP ENTRY

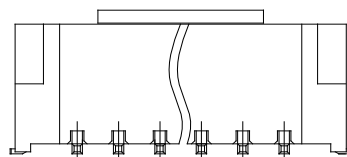
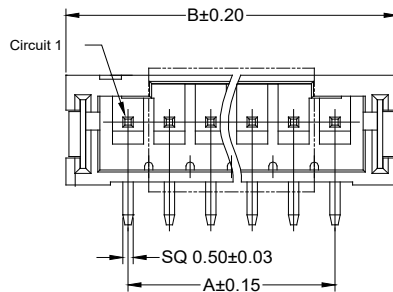

3P-16P

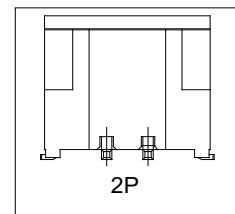

2P

140 SERIES



Wire to Board Connectors

SMT Header:

SIDE ENTRY

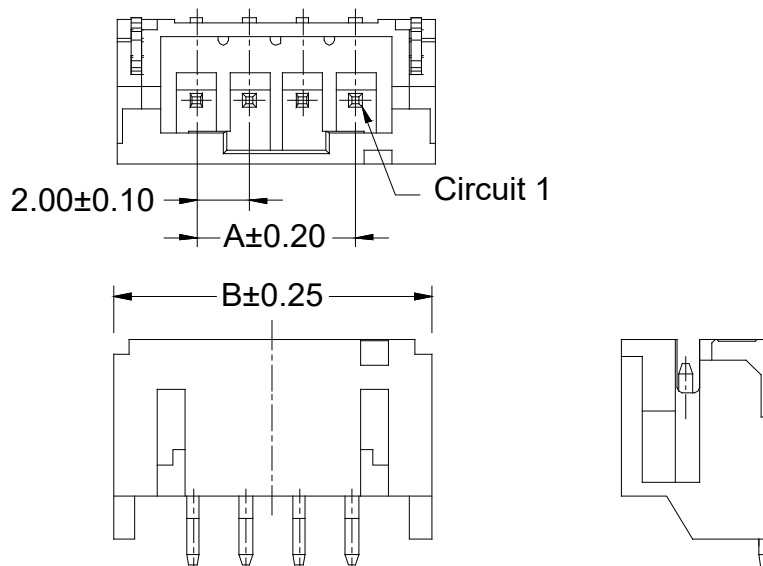

No. of Circuits	Top Entry	Side Entry		
	EDAC P/N	EDAC P/N	Dim A (mm)	Dim B (mm)
2	140-502-417-011	140-502-417-060	2.0	8.0
3	140-503-417-011	140-503-417-060	4.0	10.0
4	140-504-417-011	140-504-417-060	6.0	12.0
5	140-505-417-011	140-505-417-060	8.0	14.0
6	140-506-417-011	140-506-417-060	10.0	16.0
7	140-507-417-011	140-507-417-060	12.0	18.0
8	140-508-417-011	140-508-417-060	14.0	20.0
9	140-509-417-011	140-509-417-060	16.0	22.0
10	140-510-417-011	140-510-417-060	18.0	24.0
11	140-511-417-011	140-511-417-060	20.0	26.0
12	140-512-417-011	140-512-417-060	22.0	28.0
13	140-513-417-011	140-513-417-060	24.0	30.0
14	140-514-417-011	140-514-417-060	26.0	32.0
15	140-515-417-011	140-515-417-060	28.0	34.0
16	140-516-417-011	N/A	30.0	36.0

140 SERIES



Wire to Board Connectors

Socket Housing:

	No. of Circuits	EDAC P/N	Dim A (mm)	Dim B (mm)
	2	140-502-210-011	2.00	5.80
	3	140-503-210-011	4.00	7.80
	4	140-504-210-011	6.00	9.80
	5	140-505-210-011	8.00	11.80
	6	140-506-210-011	10.00	13.80
	7	140-507-210-011	12.00	15.80
	8	140-508-210-011	14.00	17.80
	9	140-509-210-011	16.00	19.80
	10	140-510-210-011	18.00	21.80
	11	140-511-210-011	20.00	23.80
	12	140-512-210-011	22.00	25.80
	13	140-513-210-011	24.00	27.80
	14	140-514-210-011	26.00	29.80
	15	140-515-210-011	28.00	31.80
	16	140-516-210-011	30.00	33.80

Contact:

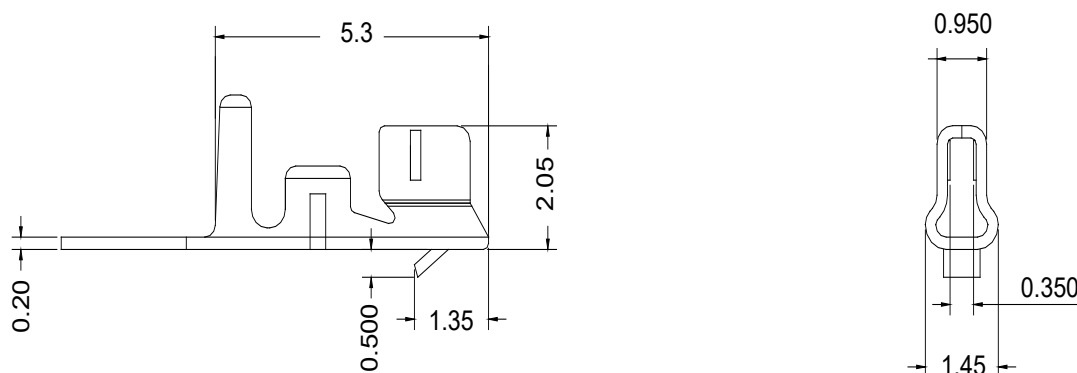

EDAC P/N	Wire Range	Insulation O.D	Material
140-941-290	24-30AWG	1.50 MAX.	Phosphor Bronze

140 SERIES



Wire to Board Connectors

PCB Layout:

Through hole top entry

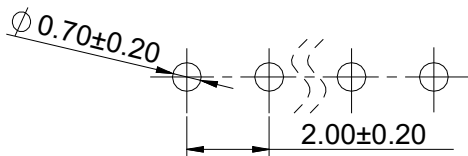

Recommended PCB Layout
PCB Thickness: 1.20~1.60mm
Tolerance: ±0.05

Through hole side entry

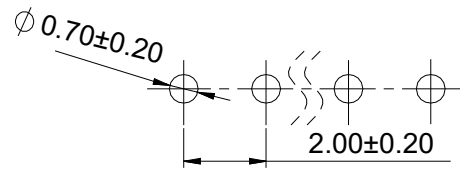

Recommended PCB Layout
PCB Thickness: 1.20~1.60mm
Tolerance: ±0.05

SMT top entry

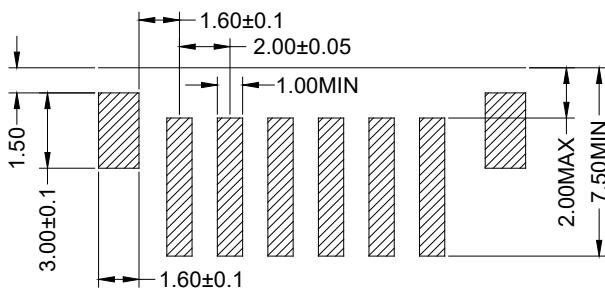

Recommended PCB Layout
PCB Thickness: 1.20~1.60mm
Tolerance: ±0.05

SMT side entry

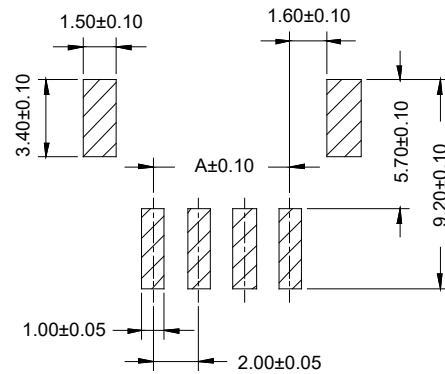

Recommended PCB Layout
PCB Thickness: 1.20~1.60mm
Tolerance: ±0.05