

VALVE CONNECTORS

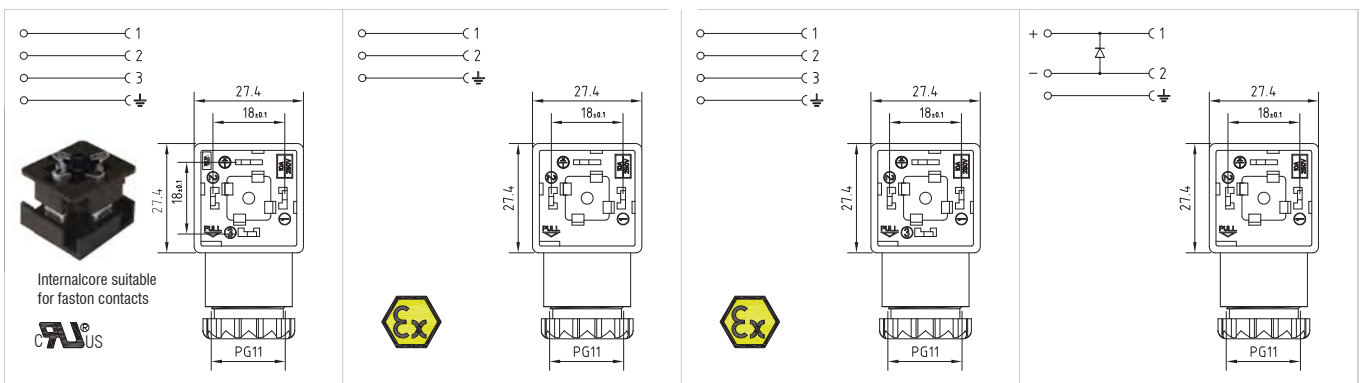

Product description

DIN valve connectors	DIN valve connectors	DIN valve connectors	DIN valve connectors
EN175301-803	EN175301-803	EN175301-803	EN175301-803
A	A	A	A
G1FNU3000-UL	G1NU2000-ATEX	G1NU3000-ATEX	G1NU2D03
Square connector G1F series, UL approved, complete with gasket and fixing screw. Connector without electronic.	Square connector G1 series, ATEX conform, complete with gasket and fixing screw. Connector without electronic.	Square connector G1 series, ATEX conform, complete with gasket and fixing screw. Connector without electronic.	Square connector G1 series complete with gasket and fixing screw. Connector with electronic.
18mm	18mm	18mm	18mm
3poles + P.E.	2poles + P.E.	3poles + P.E.	2poles + P.E.
H.12 (turnable)	H.12 (turnable)	H.12 (turnable)	H.12 (turnable)
Black	Black	Black	Black
30mm	30mm	30mm	30mm
PG9/PG11 unified	PG9/PG11 unified	PG9/PG11 unified	PG9/PG11 unified
Profiled NBR gasket	Flat Silicone gasket	Flat Silicone gasket	Profiled NBR gasket

Technical data

Female Faston contacts 6.3 x 0.8mm	Screw contacts	Screw contacts	Screw contacts
-	0.5 N*m	0.5 N*m	0.5 N*m
250V AC/ 300VDC	250V AC/ 300VDC	250V AC/ 300VDC	1-230V DC
-	-	-	Diode(1A)
-	-	-	-
∅ cable 4-8mm or ∅ cable 6.5-9.5mm	∅ cable 4-8mm or ∅ cable 6.5-9.5mm	∅ cable 4-8mm or ∅ cable 6.5-9.5mm	∅ cable 4-8mm or ∅ cable 6.5-9.5mm
M3 L=32.5mm	M3 L=32.5mm	M3 L=32.5mm	M3 L=32.5mm
Iron+Zinc plated	Iron+Zinc plated	Iron+Zinc plated	Iron+Zinc plated
0.5 N*m	0.5 N*m	0.5 N*m	0.5 N*m

Packaging

50pcs / box	Singly packed in plastic bag	Singly packed in plastic bag	50pcs / box
-------------	------------------------------	------------------------------	-------------

Other accessories options

See accessories section			
-------------------------	--	--	--

Notes:

Connector without faston contacts, the contacts must be ordered separately in reel with P/N: X-FASTON-F-6,3X0,8			
---	--	--	--

VALVE CONNECTORS

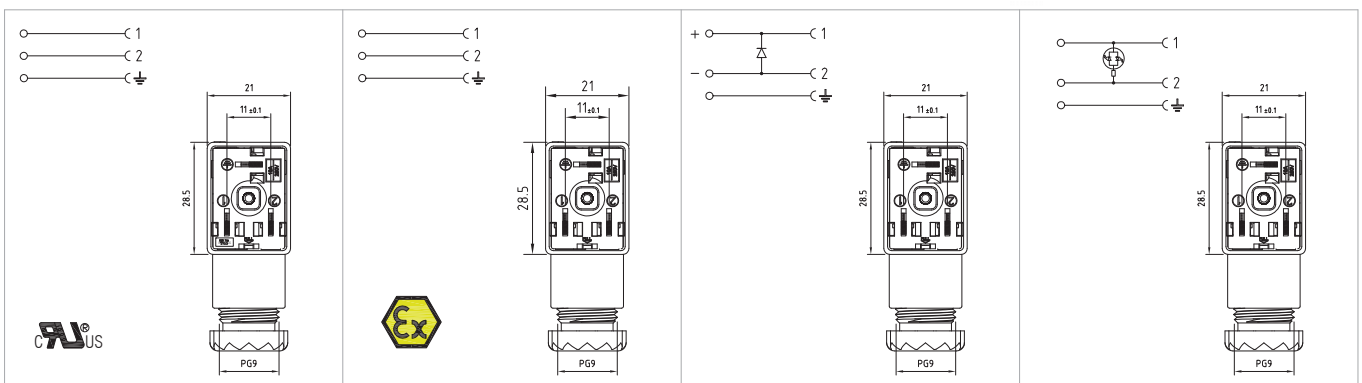

Product description

DIN valve connectors	DIN valve connectors	DIN valve connectors	DIN valve connectors
Industrial	Industrial	Industrial	Industrial
B	B	B	B
M1NS2000-UL	M1NS2000-ATEX	M1NS2D03	M1TS2L01 M1TS2L02 M1TS2L03
Rectangular connector M1 series, UL approved, complete with gasket and fixing screw. Connector without electronic.	Rectangular connector M1 series, ATEX conform, complete with gasket and fixing screw. Connector without electronic.	Rectangular connector M1 series complete with gasket and fixing screw. Connector with electronic.	Rectangular connector M1 series complete with gasket and fixing screw. Connector with electronic.
11mm	11mm	11mm	11mm
2poles + P.E.	2poles + P.E.	2poles + P.E.	2poles + P.E.
H.12 (turnable)	H.12 (turnable)	H.12 (turnable)	H.12 (turnable)
Black	Black	Black	Transparent
30mm	30mm	30mm	30mm
PG9	PG9	PG9	PG9
Profiled NBR gasket	Flat Silicone gasket	Profiled NBR gasket	Profiled NBR gasket

Technical data

Screw contacts	Screw contacts	Screw contacts	Screw contacts
0.5 N*m	0.5 N*m	0.5 N*m	0.5 N*m
250V AC/ 300VDC	250V AC/ 300VDC	1-230V DC	24V AC/DC 115V AC/DC 230V AC/DC
-	-	Diode(1A)	Bipolar Led
-	-	-	Red
ø cable 4-8mm	ø cable 4-8mm	ø cable 4-8mm	ø cable 4-8mm
M3 L=32.5mm	M3 L=32.5mm	M3 L=32.5mm	M3 L=32.5mm
Iron+Zinc plated	Iron+Zinc plated	Iron+Zinc plated	Iron+Zinc plated
0.5 N*m	0.5 N*m	0.5 N*m	0.5 N*m

Packaging

50pcs / box	Singly paked in plastic bag	50pcs / box	50pcs / box
-------------	-----------------------------	-------------	-------------

Other accessories options

See accessories section			
-------------------------	--	--	--

Notes:

Connector available with different circuits.			Connector available with different led colour
--	--	--	---

VALVE CONNECTORS

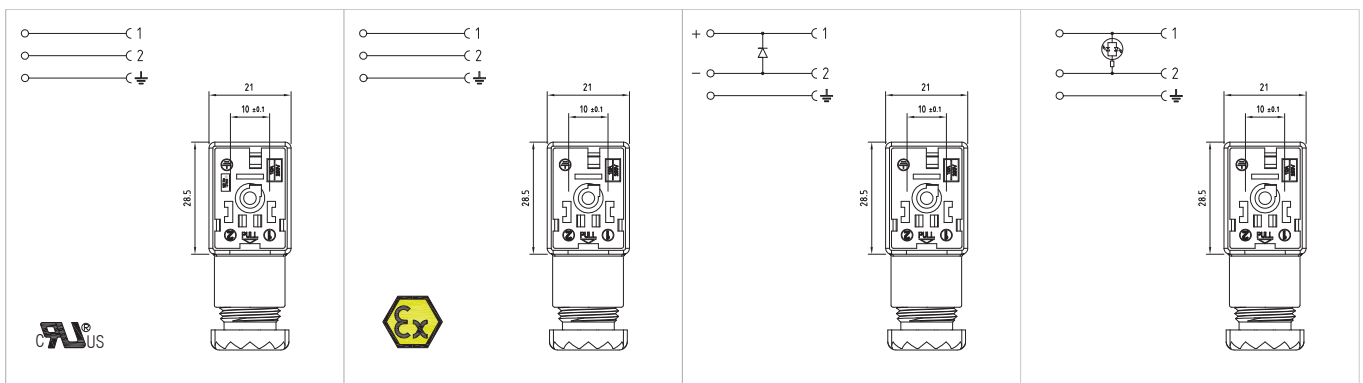

Product description

DIN valve connectors	DIN valve connectors	DIN valve connectors	DIN valve connectors
EN175301-803	EN175301-803	EN175301-803	EN175301-803
B	B	B	B
M2NS2000-UL	M2NS2000-ATEX	M2NS2D03	M2TS2L01 M2TS2L02 M2TS2L03
Rectangular connector M2 series, UL approved, complete with gasket and fixing screw. Connector without electronic.	Rectangular connector M2 series, ATEX conform, complete with gasket and fixing screw. Connector without electronic.	Rectangular connector M2 series complete with gasket and fixing screw. Connector with electronic.	Rectangular connector M2 series complete with gasket and fixing screw. Connector with electronic.
10mm	10mm	10mm	10mm
2poles + P.E.	2poles + P.E.	2poles + P.E.	2poles + P.E.
H.12 (turnable)	H.12 (turnable)	H.12 (turnable)	H.12 (turnable)
Black	Black	Black	Transparent
30mm	30mm	30mm	30mm
PG9	PG9	PG9	PG9
Profiled NBR gasket	Flat Silicone gasket	Profiled NBR gasket	Profiled NBR gasket

Technical data

Screw contacts	Screw contacts	Screw contacts	Screw contacts
0.5 N*m	0.5 N*m	0.5 N*m	0.5 N*m
250V AC/ 300VDC	250V AC/ 300VDC	1-230V DC	24V AC/DC 115V AC/DC 230V AC/DC
-	-	Diode(1A)	Bipolar Led
-	-	-	Red
ø cable 4-8mm	ø cable 4-8mm	ø cable 4-8mm	ø cable 4-8mm
M3 L=32.5mm	M3 L=32.5mm	M3 L=32.5mm	M3 L=32.5mm
Iron+Zinc plated	Iron+Zinc plated	Iron+Zinc plated	Iron+Zinc plated
0.5 N*m	0.5 N*m	0.5 N*m	0.5 N*m

Packaging

50pcs / box	Singly packed in plastic bag	50pcs / box	50pcs / box
-------------	------------------------------	-------------	-------------

Other accessories options







See accessories section

Notes:

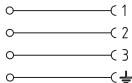
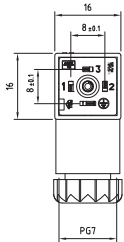
Connector available with different circuits. Connector available with different led colour

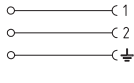
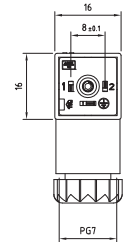
VALVE CONNECTORS

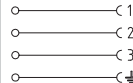
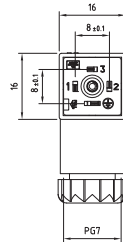

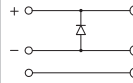
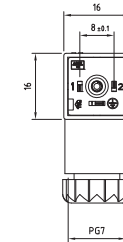
  	  	  	 
Product description			
DIN valve connectors	DIN valve connectors	DIN valve connectors	DIN valve connectors
EN175301-803	EN175301-803	EN175301-803	EN175301-803
C	C	C	C
P1NZ3000-UL	P1NZ2000-ATEX	P1NZ3000-ATEX	P1NZ2D03
Square micro connector P1 series, UL approved, complete with gasket and fixing screw. Connector without electronic.	Square micro connector P1 series, ATEX conform, complete with gasket and fixing screw. Connector without electronic.	Square micro connector P1 series, ATEX conform, complete with gasket and fixing screw. Connector without electronic.	Square micro connector P1 series complete with gasket and fixing screw. Connector with electronic.
8mm	8mm	8mm	8mm
3poles + P.E.	2poles + P.E.	3poles + P.E.	2poles + P.E.
H.6 (turnable)	H.6 (turnable)	H.6 (turnable)	H.6 (turnable)
Black	Black	Black	Black
26mm	26mm	26mm	26mm
PG7	PG7	PG7	PG7
Profiled NBR gasket	Flat Silicone gasket	Flat Silicone gasket	Flat Silicone gasket
Technical data			
Screw contacts	Screw contacts	Screw contacts	Screw contacts
0.25 N*m	0.25 N*m	0.25 N*m	0.25 N*m
250V AC/ 300VDC	250V AC/ 300VDC	250V AC/ 300VDC	1-230V DC
-	-	-	Diode(1A)
-	-	-	-
ø cable 4-6mm	ø cable 4-6mm	ø cable 4-6mm	ø cable 4-6mm
M2.5 L=28mm	M2.5 L=28mm	M2.5 L=28mm	M2.5 L=28mm
Iron + Zinc plated	Iron + Zinc plated	Iron + Zinc plated	Iron + Zinc plated
0.4 N/m	0.4 N*m	0.4 N*m	0.4 N*m
Packaging			
100pcs / box	Singly packed in plastic bag	Singly packed in plastic bag	100pcs / box
Other accessories options			
See accessories section			
Notes:			
Connector available with different circuits.			

VALVE CONNECTORS



--	--	--	--

Product description			
DIN valve connectors	DIN valve connectors	DIN valve connectors	DIN valve connectors
Industrial	Industrial	Industrial	Industrial
C	C	C	C
P2NZ3000-UL	P2NZ2000-ATEX	P2NZ3000-ATEX	P2NZ2D03
Square micro connector P2 series, UL approved, complete with gasket and fixing screw. Connector without electronic.	Square micro connector P2 series, ATEX conform, complete with gasket and fixing screw. Connector without electronic.	Square micro connector P2 series, ATEX conform, complete with gasket and fixing screw. Connector without electronic.	Square micro connector P2 series complete with gasket and fixing screw. Connector with electronic.
9.4mm	9.4mm	9.4mm	9.4mm
3poles + P.E.	2poles + P.E.	3poles + P.E.	2poles + P.E.
H.6 (turnable)	H.6 (turnable)	H.6 (turnable)	H.6 (turnable)
Black	Black	Black	Black
26mm	26mm	26mm	26mm
PG7	PG7	PG7	PG7
Profiled NBR gasket	Flat Silicone gasket	Flat Silicone gasket	Profiled NBR gasket
Technical data			
Screw contacts	Screw contacts	Screw contacts	Screw contacts
0.25 N*m	0.25 N*m	0.25 N*m	0.25 N*m
250V AC/ 300VDC	250V AC/ 300VDC	250V AC/ 300VDC	1-230V DC
-	-	-	Diode(1A)
-	-	-	-
ø cable 4-6mm	ø cable 4-6mm	ø cable 4-6mm	ø cable 4-6mm
M3 L=28mm	M3 L=28mm	M3 L=28mm	M3 L=28mm
Iron+Zinc plated	Iron+Zinc plated	Iron+Zinc plated	Iron+Zinc plated
0.5 N*m	0.5 N*m	0.5 N*m	0.5 N*m
Packaging			
100pcs / box	Singly packed in plastic bag	Singly packed in plastic bag	100pcs / box
Other accessories options			
See accessories section			
Notes:			
Connector available with different circuits.			