

## VALVE CONNECTORS

### GENERAL FEATURES:

#### Conductor cross section :

BG series: Max. 1.00mm<sup>2</sup>(19AWG).

BM series: Max. 1.00mm<sup>2</sup>(19AWG).

BP series: Max. 0.75mm<sup>2</sup> (18AWG).

#### Fixing system :

Central fixing screw.

#### Max- screw torque IEC60947-1

(Central fixing nut) :

BG series - BM1series - BP2 series: Max. 0.5 N \* m.

BP1 series: Max. 0.4 N \* m.

#### Type of terminations :

To Solder.

#### Contact material and treatment :

Brass + Silver plated.

#### Base material :

PA66.

#### Flammability resistance :

UL94-V2 - Standard.

UL94-V0 - UL approved (upon request).

#### Protection class :

IP 65 coupled.

#### Operating temperature :

-40°C +90°C with NBR gasket.

-40°C +125°C with Silicone gasket.

#### Nominal current :

10A (BP1-BP2 series: 6A).

#### Max contact current :

16A (BP1-BP2 series: 10A).

In2Connect UK Ltd

Unit L, Tyson Courtyard

Weldon South Industrial Estate

Corby

Northants

NN18 8AZ

Tel: 01962 773004

sales@in2connect.uk.com

BG1 N 0 2 00 0 - ##

#### SERIES

**BG0** : SQUARE EN175301-803 BASE form A (18mm) WITH No.4 FIXING HOLES.

**BG1** : SQUARE EN175301-803 BASE form A (18mm) WITH No.4 FIXING HOLES.

**BG4** : SQUARE EN175301-803 BASE form A (18mm) WITH No.4 FIXING HOLES + CIRCULAR PART ø22mm.

**BG5** : SQUARE EN175301-803 BASE form A (18mm) WITH No.2 FIXING HOLES.

**BG7** : CIRCULAR EN175301-803 form A (18mm) ø27mm.

**BG8** : SQUARE EN175301-803 form A (18mm) SUITABLE FOR CYLINDERS ø80mm.

**BG10** : SQUARE EN175301-803 form A (18mm) SUITABLE FOR CYLINDERS ø100mm.

**BG16** : SQUARE EN175301-803 form A (18mm) SUITABLE FOR CYLINDERS ø160mm.

**BG33** : SQUARE EN175301-803 form A (18mm) SUITABLE FOR CYLINDERS ø33mm.

**BG42** : SQUARE EN175301-803 form A (18mm) SUITABLE FOR CYLINDERS ø42mm.

**BGR** : CIRCULAR EN175301-803 form A (18mm) with M27 FIXING CIRCULAR NUT.

**BM1** : RECTANGULAR INDUSTRIAL form B (11mm)

**BP1** : SQUARE MICRO EN175301-803 form C (8mm)

**BP2** : SQUARE MICRO INDUSTRIAL form C (9.4mm)

**BP3** : SQUARE MICRO INDUSTRIAL form C (9.4mm) WITH CIRCULAR PART ø15.2mm.

#### COLOUR

G : GREY. N : BLACK (STANDARD). T : TRANSPARENT.

#### 0

#### POLES No.

2 : 2POLES + EARTH. 3 : 3POLES + EARTH.

#### CIRCUIT TYPE

00 : WITHOUT ELECTRONIC.

#### VOLTAGE

0 : 250V / 300V.

#### SOME VARIABLES

UL : UL APPROVED.

PG11 : BGR SERIES WITH ADAPTER FROM M27 TO PG11.

PG13.5 : BGR SERIES WITH ADAPTER FROM M27 TO PG13.5.

M20 : BGR SERIES WITH ADAPTER FROM M27 TO M20X1.5.

1/2" NPTF : BGR SERIES WITH ADAPTER FROM M27 TO 1/2" NPTF.

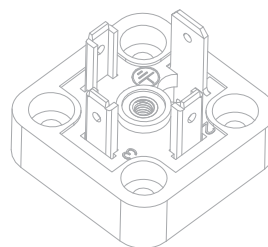
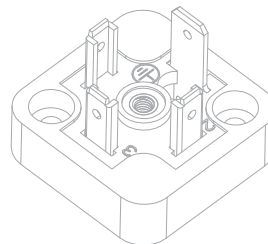

## VALVE CONNECTORS



### Technical drawing

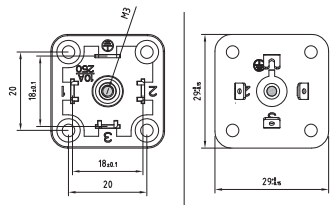
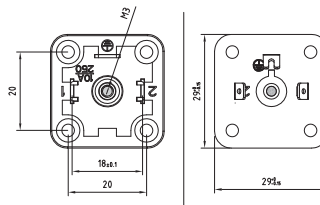
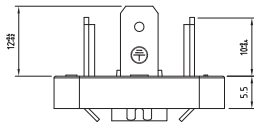

### Product description

Connector type	Square base for DIN valve connectors	Square base for DIN valve connectors
Conforms to	EN175301-803	EN175301-803
Construction type	A	A
Part number	<b>BG0N02000</b>	<b>BG0N03000</b>
Description	Square base connector BG0 series complete with gasket and fixing screws.	Square base connector BG0 series complete with gasket and fixing screws.
Contacts spacing	18mm	18mm
Number of contacts	2poles + P.E.	3poles + P.E.
Earth positioning	-	-
Base colour	Black	Black
Base height	5.5mm	5.5mm
Gasket type	Flat NBR gasket	Flat NBR gasket

### Technical data

Rated voltage	250V AC/ 300VDC	250V AC/ 300VDC
Number of fixing holes	N°4	N°4
Diameter of fixing holes	ø3.2mm	ø3.2mm
Fixing screws material (x4)	Iron + Zinc plated	Iron + Zinc plated
Fixing screws length (x4)	M3 L=7.3mm	M3 L=7.3mm
Fixing screws torque (x4)	0.5 N*m	0.5 N*m
Earth fixing screw material	-	-
Earth fixing screws length	-	-
Earth screw torque	-	-
Central nut type	M3 Closed	M3 Closed

### Packaging

Qty/Box	200pcs / box	200pcs / box
---------	--------------	--------------

### Other accessories options

See accessories section

### Notes:

Base in Grey colour: P/N BG0G02000

Base in Grey colour: P/N BG0G03000

## VALVE CONNECTORS

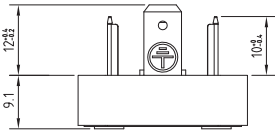
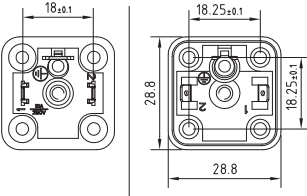
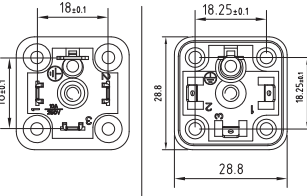
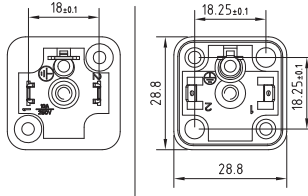

<b>Technical drawing</b>			
			
<b>Product description</b>			
Connector type	Square base for DIN valve connectors	Square base for DIN valve connectors	Square base for DIN valve connectors
Conforms to	EN175301-803	EN175301-803	EN175301-803
Construction type	A	A	A
Part number	<b>BG1N02000</b>	<b>BG1N03000</b>	<b>BG5N02000</b>
Description	Square base connector BG1 series complete with gasket and fixing screws.	Square base connector BG1 series complete with gasket and fixing screws.	Square base connector BG5 series complete with gasket and fixing screws.
Contacts spacing	18mm	18mm	18mm
Number of contacts	2poles + P.E.	3poles + P.E.	2poles + P.E.
Earth positioning	-	-	-
Base colour	Black	Black	Black
Base height	9.1mm	9.1mm	9.1mm
Gasket type	Flat NBR gasket	Flat NBR gasket	Flat NBR gasket
<b>Technical data</b>			
Rated voltage	250V AC/ 300VDC	250V AC/ 300VDC	250V AC/ 300VDC
Number of fixing holes	N°4	N°4	N°2
Diameter of fixing holes	ø3.2mm	ø3.2mm	ø3.2mm
Fixing screws material (x4)	Iron+Zinc plated	Iron+Zinc plated	Iron+Zinc plated
Fixing screws length (x4)	M3 L=10mm	M3 L=10mm	M3 L=10mm
Fixing screws torque (x4)	0.5 N*m	0.5 N*m	0.5 N*m
Earth fixing screw material	Iron+Zinc plated	Iron+Zinc plated	Iron+Zinc plated
Earth fixing screws length	M3 L=4.8mm	M3 L=4.8mm	M3 L=4.8mm
Earth screw torque	0.5 N*m	0.5 N*m	0.5 N*m
Central nut type	M3 Open	M3 Open	M3 Open
<b>Packaging</b>			
Qty/Box	200pcs / box	200pcs / box	200pcs / box
<b>Other accessories options</b>			
See accessories section			
<b>Notes:</b>			
	Base in Grey colour: P/N BG1G02000	Base in Grey colour: P/N BG1G03000	Base in Grey colour: P/N BG5G02000

## VALVE CONNECTORS

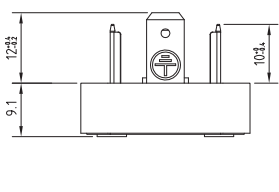
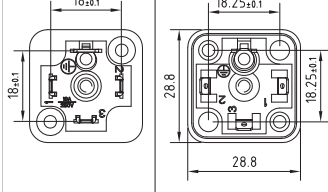
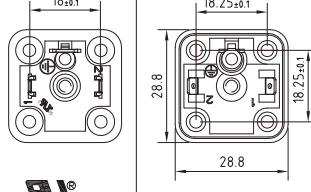
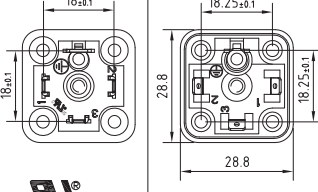

<b>Technical drawing</b>			
			
<b>Product description</b>			
Connector type	Square base for DIN valve connectors	Square base for DIN valve connectors	Square base for DIN valve connectors
Conforms to	EN175301-803	EN175301-803	EN175301-803
Construction type	A	A	A
Part number	<b>BG5N03000</b>	<b>BG1N02000-UL</b>	<b>BG1N03000-UL</b>
Description	Square base connector BG5 series complete with gasket and fixing screws.	Square base connector BG1 series, UL approved, complete with gasket and fixing screws.	Square base connector BG1 series, UL approved, complete with gasket and fixing screws.
Contacts spacing	18mm	18mm	18mm
Number of contacts	3poles + P.E.	2poles + P.E.	3poles + P.E.
Earth positioning	-	-	-
Base colour	Black	Black	Black
Base height	9.1mm	9.1mm	9.1mm
Gasket type	Flat NBR gasket	Flat NBR gasket	Flat NBR gasket
<b>Technical data</b>			
Rated voltage	250V AC/ 300VDC	250V AC/ 300VDC	250V AC/ 300VDC
Number of fixing holes	N°2	N°4	N°4
Diameter of fixing holes	ø3.2mm	ø3.2mm	ø3.2mm
Fixing screws material (x4)	Iron+Zinc plated	Iron+Zinc plated	Iron+Zinc plated
Fixing screws length (x4)	M3 L=10mm	M3 L=10mm	M3 L=10mm
Fixing screws torque (x4)	0.5 N*m	0.5 N*m	0.5 N*m
Earth fixing screw material	Iron+Zinc plated	Iron+Zinc plated	Iron+Zinc plated
Earth fixing screws length	M3 L=4.8mm	M3 L=4.8mm	M3 L=4.8mm
Earth screw torque	0.5 N*m	0.5 N*m	0.5 N*m
Central nut type	M3 Open	M3 Open	M3 Open
<b>Packaging</b>			
Qty/Box	200pcs / box	200pcs / box	200pcs / box
<b>Other accessories options</b>			
See accessories section			
<b>Notes:</b>			
	Base in Grey colour: P/N BG5G03000		

## VALVE CONNECTORS

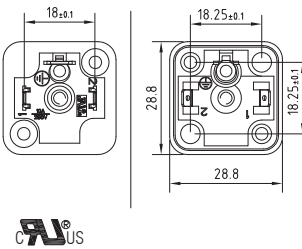
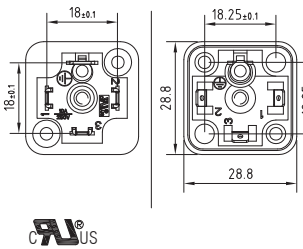

			
<b>Product description</b>			
Square base for DIN valve connectors	Square base for DIN valve connectors		
EN175301-803	EN175301-803		
A	A		
<b>BG5N02000-UL</b>	<b>BG5N03000-UL</b>		
Square base connector BG5 series, UL approved, complete with gasket and fixing screws.	Square base connector BG5 series, UL approved, complete with gasket and fixing screws.		
18mm	18mm		
2poles + P.E.	3poles + P.E.		
-	-		
Black	Black		
9.1mm	9.1mm		
Flat NBR gasket	Flat NBR gasket		
<b>Technical data</b>			
250V AC/ 300VDC	250V AC/ 300VDC		
N°2	N°2		
ø3.2mm	ø3.2mm		
Iron+Zinc plated	Iron+Zinc plated		
M3 L=10mm	M3 L=10mm		
0.5 N*m	0.5 N*m		
Iron+Zinc plated	Iron+Zinc plated		
M3 L=4.8mm	M3 L=4.8mm		
0.5 N*m	0.5 N*m		
M3 Open	M3 Open		
<b>Packaging</b>			
200pcs / box	200pcs / box		
<b>Other accessories options</b>			
See accessories section			
<b>Notes:</b>			

## VALVE CONNECTORS



### Technical drawing

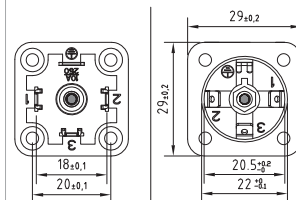
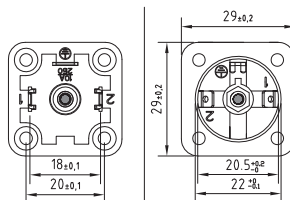
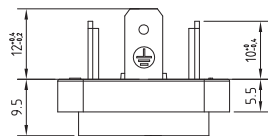

### Product description

Connector type	Square base for DIN valve connectors	Square base for DIN valve connectors
Conforms to	EN175301-803	EN175301-803
Construction type	A	A
Part number	<b>BG4N02000</b>	<b>BG4N03000</b>
Description	Square base connector BG4 series complete with gasket and fixing screws.	Square base connector BG4 series complete with gasket and fixing screws.
Contacts spacing	18mm	18mm
Number of contacts	2poles + P.E.	3poles + P.E.
Earth positioning	-	-
Base colour	Black	Black
Base height	9.5mm	9.5mm
Gasket type	Flat NBR gasket	Flat NBR gasket

### Technical data

Rated voltage	250V AC/ 300VDC	250V AC/ 300VDC
Number of fixing holes	N°4	N°4
Diameter of fixing holes	ø3.2mm	ø3.2mm
Fixing screws material (x4)	Iron + Zinc plated	Iron + Zinc plated
Fixing screws length (x4)	M3 L=7.3mm	M3 L=7.3mm
Fixing screws torque (x4)	0.5 N*m	0.5 N*m
Earth fixing screw material	-	-
Earth fixing screws length	-	-
Earth screw torque	-	-
Central nut type	M3 Hexagonal closed	M3 Hexagonal closed

### Packaging

Qty/Box	200pcs / box	200pcs / box
---------	--------------	--------------

### Other accessories options

See accessories section

### Notes:

Base in Grey colour: P/N BG4G02000

Base in Grey colour: P/N BG4G03000

## VALVE CONNECTORS

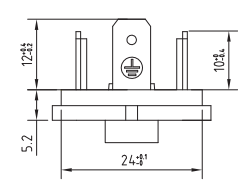
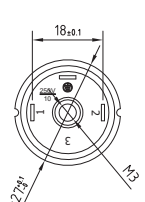
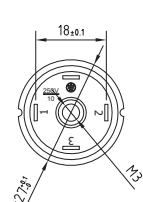

<b>Technical drawing</b>		
		
<b>Product description</b>		
Connector type	Circular base for DIN valve connectors	Circular base for DIN valve connectors
Conforms to	EN175301-803	EN175301-803
Construction type	A	A
Part number	<b>BG7N02000</b>	<b>BG7N03000</b>
Description	Circular base connector BG7 series without gasket and fixing screws.	Circular base connector BG7 series without gasket and fixing screws.
Contacts spacing	18mm	18mm
Number of contacts	2poles + P.E.	3poles + P.E.
Earth positioning	-	-
Base colour	Black	Black
Base height	5.2mm	5.2mm
Gasket type	-	-
<b>Technical data</b>		
Rated voltage	250V AC/ 300VDC	250V AC/ 300VDC
Number of fixing holes	-	-
Diameter of fixing holes	-	-
Fixing screws material	-	-
Fixing screws length	-	-
Fixing screws torque	-	-
Earth fixing screw material	-	-
Earth fixing screws length	-	-
Earth screw torque	-	-
Central nut type	M3 Closed	M3 Closed
<b>Packaging</b>		
Qty/Box	200pcs / box	200pcs / box
<b>Other accessories options</b>		
See accessories section		
<b>Notes:</b>	Base in Grey colour: P/N BG7G02000	Base in Grey colour: P/N BG7G03000

## VALVE CONNECTORS

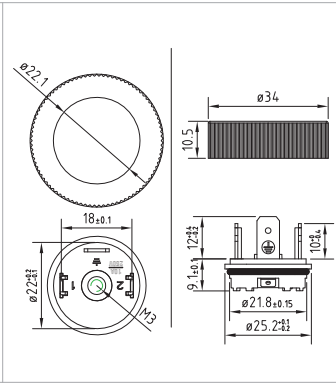
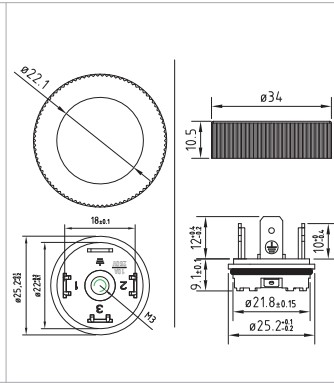
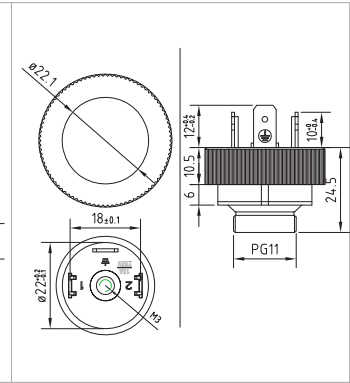

Technical drawing				
<b>Product description</b>				
Connector type	Circular base for DIN valve connectors	Circular base for DIN valve connectors	Circular base for DIN valve connectors	Circular base for DIN valve connectors
Conforms to	EN175301-803	EN175301-803	EN175301-803	EN175301-803
Construction type	A	A	A	A
Part number	<b>BGRN02000</b>	<b>BGRN03000</b>	<b>BGRN02000-PG11</b>	
Description	Circular base connector BGR series with plastic fixing nut M27X1.5. Base without fixing screws	Circular base connector BGR series with plastic fixing nut M27X1.5. Base without fixing screws	Circular base connector BGR series with plastic fixing nut M27X1.5+PG11 reduction. Base without fixing screws	
Contacts spacing	18mm	18mm	18mm	
Number of contacts	2poles + P.E.	3poles + P.E.	2poles + P.E.	
Earth positioning	-	-	-	
Base colour	Black	Black	Black	
Base height	10.5mm (with plastic fixing nut)	10.5mm (with plastic fixing nut)	24.5mm (with fixing nut and reduction)	
Gasket type	-	-	-	
<b>Technical data</b>				
Rated voltage	250V AC/ 300VDC	250V AC/ 300VDC	250V AC/ 300VDC	
Number of fixing holes	-	-	-	
Diameter of fixing holes	-	-	-	
Fixing screws material	-	-	-	
Fixing screws length	-	-	-	
Fixing screws torque	-	-	-	
Earth fixing screw material	-	-	-	
Earth fixing screws length	-	-	-	
Earth screw torque	-	-	-	
Central nut type	M3 Open	M3 Open	M3 Open	
Reduction type	-	-	From M27x1.5 to PG11	
<b>Packaging</b>				
Qty/Box	200pcs / box	200pcs / box	200pcs / box	
<b>Other accessories options</b>				
See accessories section				
<b>Notes:</b>	Base in Grey colour: P/N BGRG02000	Base in Grey colour: P/N BGRG03000		



## VALVE CONNECTORS

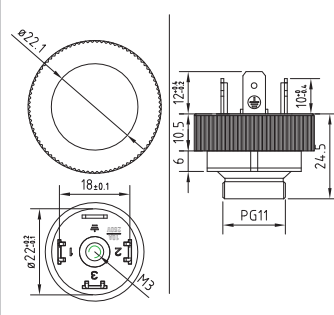
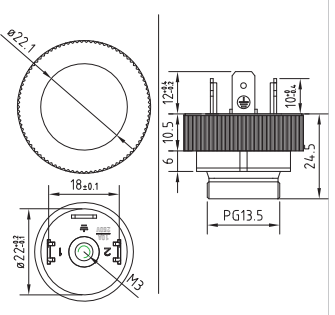
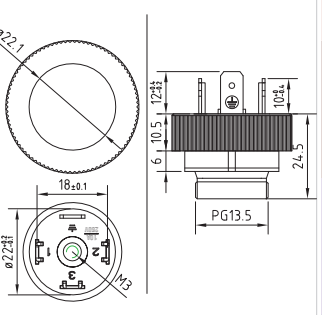

Technical drawing				
<b>Product description</b>				
Connector type	Circular base for DIN valve connectors	Circular base for DIN valve connectors	Circular base for DIN valve connectors	Circular base for DIN valve connectors
Conforms to	EN175301-803	EN175301-803	EN175301-803	EN175301-803
Construction type	A	A	A	A
Part number	<b>BGRN03000-PG11</b>	<b>BGRN02000-PG13.5</b>	<b>BGRN03000-PG13.5</b>	<b>BGRN03000-PG13.5</b>
Description	Circular base connector BGR series with plastic fixing nut M27X1.5+PG11 reduction. Base without fixing screws	Circular base connector BGR series with plastic fixing nut M27X1.5+PG13.5 reduction. Base without fixing screws	Circular base connector BGR series with plastic fixing nut M27X1.5+PG13.5 reduction. Base without fixing screws	Circular base connector BGR series with plastic fixing nut M27X1.5+PG13.5 reduction. Base without fixing screws
Contacts spacing	18mm	18mm	18mm	18mm
Number of contacts	3poles + P.E.	2poles + P.E.	3poles + P.E.	3poles + P.E.
Earth positioning	-	-	-	-
Base colour	Black	Black	Black	Black
Base height	24.5mm (with fixing nut and reduction)	24.5mm (with fixing nut and reduction)	24.5mm (with fixing nut and reduction)	24.5mm (with fixing nut and reduction)
Gasket type	-	-	-	-
<b>Technical data</b>				
Rated voltage	250V AC/ 300VDC	250V AC/ 300VDC	250V AC/ 300VDC	250V AC/ 300VDC
Number of fixing holes	-	-	-	-
Diameter of fixing holes	-	-	-	-
Fixing screws material	-	-	-	-
Fixing screws length	-	-	-	-
Fixing screws torque	-	-	-	-
Earth fixing screw material	-	-	-	-
Earth fixing screws length	-	-	-	-
Earth screw torque	-	-	-	-
Central nut type	M3 Open	M3 Open	M3 Open	M3 Open
Reduction type	From M27x1.5 to PG11	From M27x1.5 to PG13.5	From M27x1.5 to PG13.5	From M27x1.5 to PG13.5
<b>Packaging</b>				
Qty/Box	200pcs / box	200pcs / box	200pcs / box	200pcs / box
<b>Other accessories options</b>				
See accessories section				
<b>Notes:</b>				

## VALVE CONNECTORS

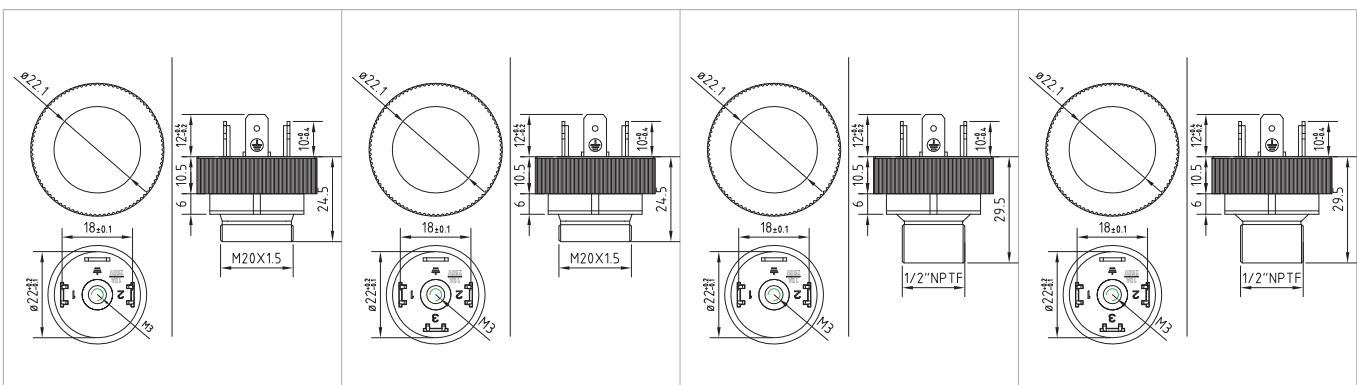

### Product description

Circular base for DIN valve connectors	Circular base for DIN valve connectors	Circular base for DIN valve connectors	Circular base for DIN valve connectors
EN175301-803	EN175301-803	EN175301-803	EN175301-803
A	A	A	A
<b>BGRN02000-M20</b>	<b>BGRN03000-M20</b>	<b>BGRN02000-1/2NPTF</b>	<b>BGRN03000-1/2NPTF</b>
Circular base connector BGR series with plastic fixing nut M27X1.5 + M20x1.5 reduction. Base without fixing screws	Circular base connector BGR series with plastic fixing nut M27X1.5 + M20x1.5 reduction. Base without fixing screws	Circular base connector BGR series with plastic fixing nut M27X1.5 + 1/2NPTF reduction. Base without fixing screws	Circular base connector BGR series with plastic fixing nut M27X1.5 + 1/2NPTF reduction. Base without fixing screws
18mm	18mm	18mm	18mm
2poles + P.E.	3poles + P.E.	2poles + P.E.	3poles + P.E.
-	-	-	-
Black	Black	Black	Black
24.5mm (with fixing nut and reduction)	24.5mm (with fixing nut and reduction)	29.5mm (with fixing nut and reduction)	29.5mm (with fixing nut and reduction)
-	-	-	-

### Technical data

250V AC/ 300VDC	250V AC/ 300VDC	250V AC/ 300VDC	250V AC/ 300VDC
-	-	-	-
-	-	-	-
-	-	-	-
-	-	-	-
-	-	-	-
-	-	-	-
-	-	-	-
M3 Open	M3 Open	M3 Open	M3 Open
From M27x1.5 to M20x1.5	From M27x1.5 to M20x1.5	From M27x1.5 to 1/2"NPTF	From M27x1.5 to 1/2"NPTF

### Packaging

200pcs / box	200pcs / box	200pcs / box	200pcs / box
--------------	--------------	--------------	--------------

### Other accessories options

See accessories section

### Notes:

## VALVE CONNECTORS

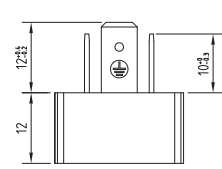
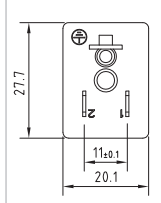
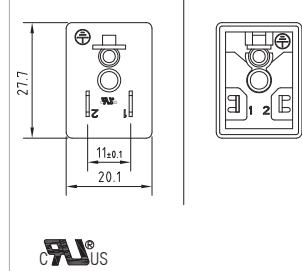

<b>Technical drawing</b>		
		
<b>Product description</b>		
Connector type	Rectangular base for DIN valve connectors	Rectangular base for DIN valve connectors
Conforms to	Industrial	Industrial
Construction type	B	B
Part number	<b>BM1N02000</b>	<b>BM1N02000-UL</b>
Description	Rectangular base connector BM1 series complete with gasket and fixing screws.	Rectangular base connector BM1 series, UL approved, complete with gasket and fixing screws.
Contacts spacing	11mm	11mm
Number of contacts	2poles + P.E.	2poles + P.E.
Earth positioning	-	-
Base colour	Black	Black
Base height	12mm	12mm
Gasket type	Flat NBR gasket	Flat NBR gasket
<b>Technical data</b>		
Rated voltage	250V AC/ 300VDC	250V AC/ 300VDC
Number of fixing holes	-	-
Diameter of fixing holes	-	-
Fixing screws material (x1)	Iron+Zinc plated	Iron+Zinc plated
Fixing screws length (x1)	M3(int.)-M4(ext.) L=15.5mm	M3(int.)-M4(ext.) L=15.5mm
Fixing screws torque (x1)	0.5 N*m	0.5 N*m
Earth fixing screw material	Iron+Zinc plated	Iron+Zinc plated
Earth fixing screws length	M3 L=5mm	M3 L=5mm
Earth screw torque	0.5 N*m	0.5 N*m
Central nut type	-	-
<b>Packaging</b>		
Qty/Box	200pcs / box	200pcs / box
<b>Other accessories options</b>		
See accessories section		
<b>Notes:</b>		
	Base in Grey colour: P/N BM1G02000	

## VALVE CONNECTORS

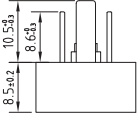
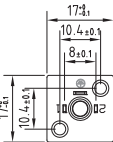
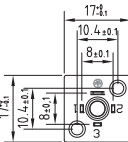
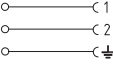
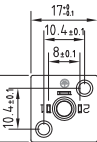
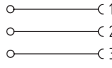

<b>Technical drawing</b>				
				
<b>Product description</b>				
Connector type	Square base for DIN valve connectors	Square base for DIN valve connectors	Square base for DIN valve connectors	Square base for DIN valve connectors
Conforms to	EN175301-803	EN175301-803	EN175301-803	EN175301-803
Construction type	C	C	C	C
Part number	<b>BP1N02000</b>	<b>BP1N02000</b>	<b>BP1N03000</b>	<b>BP1N03000</b>
Description	Square base connector BP1 series complete with gasket and fixing screws.	Square base connector BP1 series complete with gasket and fixing screws.	Square base connector BP1 series complete with gasket and fixing screws.	Square base connector BP1 series complete with gasket and fixing screws.
Contacts spacing	8mm	8mm	8mm	8mm
Number of contacts	2poles + P.E.	2poles + P.E.	3poles + P.E.	3poles + P.E.
Earth positioning	-	-	-	-
Base colour	Black	Black	Black	Black
Base height	8.5mm	8.5mm	8.5mm	8.5mm
Gasket type	Flat NBR gasket	Flat NBR gasket	Flat NBR gasket	Flat NBR gasket
<b>Technical data</b>				
Rated voltage	250V AC/ 300VDC	250V AC/ 300VDC	250V AC/ 300VDC	250V AC/ 300VDC
Number of fixing holes	N°2	N°2	N°2	N°2
Diameter of fixing holes	ø3mm	ø3mm	ø3mm	ø3mm
Fixing screws material (x1)	Iron + Zinc plated	Iron + Zinc plated	Iron + Zinc plated	Iron + Zinc plated
Fixing screws length (x1)	M2.5 L=8mm	M2.5 L=8mm	M2.5 L=8mm	M2.5 L=8mm
Fixing screws torque (x1)	0.4 N*m	0.4 N*m	0.4 N*m	0.4 N*m
Earth fixing screw material	Iron + Zinc plated	Iron + Zinc plated	Iron + Zinc plated	Iron + Zinc plated
Earth fixing screws length	-	-	-	-
Earth screw torque	-	-	-	-
Central nut type	M2.5 Open	M2.5 Open	M2.5 Open	M2.5 Open
<b>Packaging</b>				
Qty/Box	200pcs / box	200pcs / box	200pcs / box	200pcs / box
<b>Other accessories options</b>				
to be ordered separately see page				
<b>Notes:</b>				
		Base in Grey colour: P/N BP1G02000	Base in Grey colour: P/N BP1G03000	

## VALVE CONNECTORS

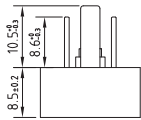
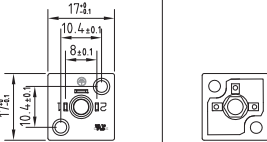
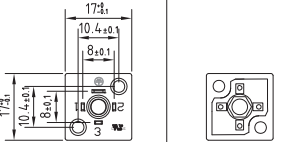

	 <p style="text-align: center;">C<sup>RU</sup> US</p>	 <p style="text-align: center;">C<sup>RU</sup> US</p>
<b>Product description</b>		
Connector type	Square base for DIN valve connectors	Square base for DIN valve connectors
Conforms to	EN175301-803	EN175301-803
Construction type	C	C
Part number	<b>BP1N02000-UL</b>	<b>BP1N03000-UL</b>
Description	Square base connector BP1 series, UL approved, complete with gasket and fixing screws.	Square base connector BP1 series, UL approved, complete with gasket and fixing screws.
Contacts spacing	8mm	8mm
Number of contacts	2poles + P.E.	3poles + P.E.
Earth positioning	-	-
Base colour	Black	Black
Base height	8.5mm	8.5mm
Gasket type	Flat NBR gasket	Flat NBR gasket
<b>Technical data</b>		
Rated voltage	250V AC/ 300VDC	250V AC/ 300VDC
Number of fixing holes	N°2	N°2
Diameter of fixing holes	ø3mm	ø3mm
Fixing screws material (x1)	Iron+Zinc plated	Iron+Zinc plated
Fixing screws length (x1)	M2.5 L=8mm	M2.5 L=8mm
Fixing screws torque (x1)	0.4 N*m	0.4 N*m
Earth fixing screw material	Iron+Zinc plated	Iron+Zinc plated
Earth fixing screws length	-	-
Earth screw torque	-	-
Central nut type	M2.5 Open	M2.5 Open
<b>Packaging</b>		
Qty/Box	200pcs / box	200pcs / box
<b>Other accessories options</b>		
to be ordered separately see page		
<b>Notes:</b>		

## VALVE CONNECTORS

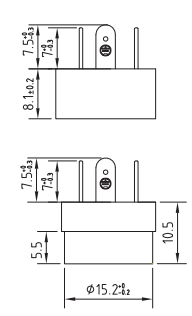
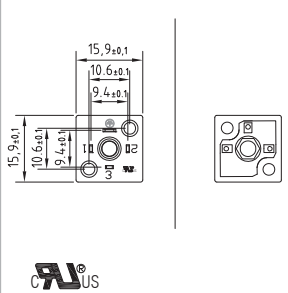
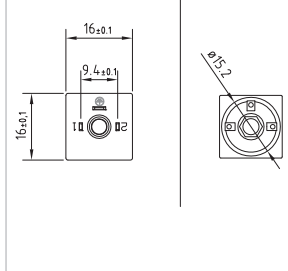
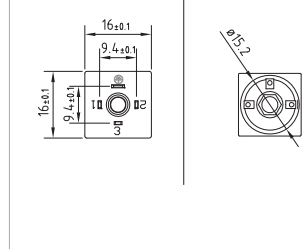

Technical drawing			
			
<b>Product description</b>			
Connector type	Square base for DIN valve connectors	Square base for DIN valve connectors	Square base for DIN valve connectors
Conforms to	Industrial	Industrial	Industrial
Construction type	C	C	C
Part number	<b>BP2N03000-UL</b>	<b>BP3N02000</b>	<b>BP3N03000</b>
Description	Square base connector BP2 series, UL approved, complete with gasket and fixing screws.	Square base connector BP3 series complete with gasket	Square base connector BP3 series complete with gasket
Contacts spacing	9,4mm	9,4mm	9,4mm
Number of contacts	3poles + P.E.	2poles + P.E.	3poles + P.E.
Earth positioning	-	-	-
Base colour	Black	Black	Black
Base height	8.5mm	10.5mm	10.5mm
Gasket type	Flat NBR gasket	Flat NBR gasket	Flat NBR gasket
<b>Technical data</b>			
Rated voltage	250V AC/ 300VDC	250V AC/ 300VDC	250V AC/ 300VDC
Number of fixing holes	N°2	-	-
Diameter of fixing holes	ø3mm	-	-
Fixing screws material (x1)	Iron + Zinc plated	-	-
Fixing screws length (x1)	M3 L=8mm	-	-
Fixing screws torque (x1)	0.5 N*m	-	-
Earth fixing screw material	Iron + Zinc plated	-	-
Earth fixing screws length	-	-	-
Earth screw torque	-	-	-
Central nut type	M3 Open	M3 Open	M3 Open
<b>Packaging</b>			
Qty/Box	200pcs / box	200pcs / box	200pcs / box
<b>Other accessories options</b> to be ordered separately see page			
<b>Notes:</b>		Base in Grey colour: P/N BP3G02000	Base in Grey colour: P/N BP3G03000

## VALVE CONNECTORS

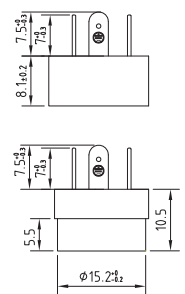
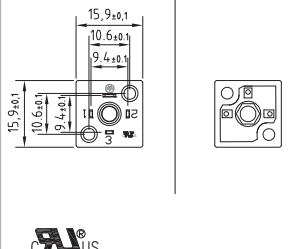
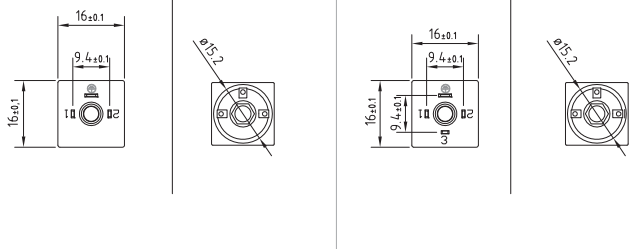

Technical drawing			
			
Product description			
Connector type	Square base for DIN valve connectors	Square base for DIN valve connectors	Square base for DIN valve connectors
Conforms to	Industrial	Industrial	Industrial
Construction type	C	C	C
Part number	<b>BP2N03000-UL</b>	<b>BP3N02000</b>	<b>BP3N03000</b>
Description	Square base connector BP2 series, UL approved, complete with gasket and fixing screws.	Square base connector BP3 series complete with gasket	Square base connector BP3 series complete with gasket
Contacts spacing	9,4mm	9.4mm	9.4mm
Number of contacts	3poles + P.E.	2poles + P.E.	3poles + P.E.
Earth positioning	-	-	-
Base colour	Black	Black	Black
Base height	8.5mm	10.5mm	10.5mm
Gasket type	Flat NBR gasket	Flat NBR gasket	Flat NBR gasket
Technical data			
Rated voltage	250V AC/ 300VDC	250V AC/ 300VDC	250V AC/ 300VDC
Number of fixing holes	N°2	-	-
Diameter of fixing holes	ø3mm	-	-
Fixing screws material (x1)	Iron + Zinc plated	-	-
Fixing screws length (x1)	M3 L=8mm	-	-
Fixing screws torque (x1)	0.5 N*m	-	-
Earth fixing screw material	Iron + Zinc plated	-	-
Earth fixing screws length	-	-	-
Earth screw torque	-	-	-
Central nut type	M3 Open	M3 Open	M3 Open
Packaging			
Qty/Box	200pcs / box	200pcs / box	200pcs / box
Other accessories options			
to be ordered separately see page			
Notes:			
		Base in Grey colour: P/N BP3G02000	Base in Grey colour: P/N BP3G03000

## VALVE CONNECTORS



### Technical drawing

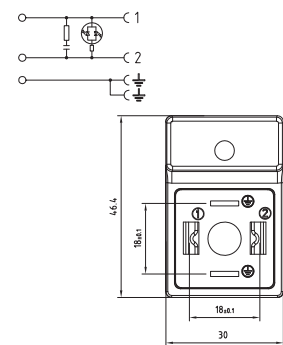
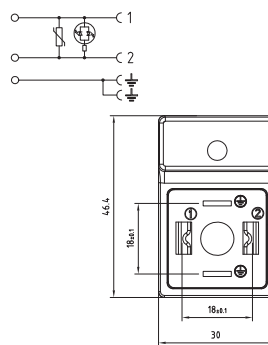
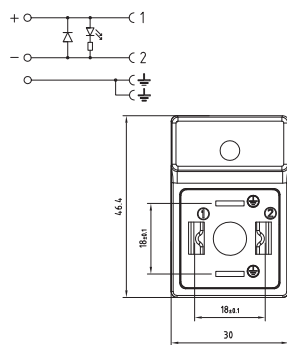
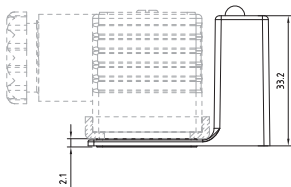

### Product description

Connector type	Adapter base for DIN valve connectors			Adapter base for DIN valve connectors			Adapter base for DIN valve connectors		
Conforms to	EN175301-803			EN175301-803			EN175301-803		
Construction type	A			A			A		
Part number	<b>AG1N02DL1</b>	<b>AG1N02DL2</b>	<b>AG1N02DL3</b>	<b>AG1N02VL1</b>	<b>AG1N02VL2</b>	<b>AG1N02VL3</b>	<b>AG1N02FL1</b>	<b>AG1N02FL2</b>	<b>AG1N02FL3</b>
Description	Square Angled 90° adapter AG1 series			Square Angled 90° adapter AG1 series			Square Angled 90° adapter AG1 series		
Contacts spacing	18mm			18mm			18mm		
Number of contacts	2poles + 2P.E.			2poles + 2P.E.			2poles + 2P.E.		
Earth positioning	H.6-12			H.6-12			H.6-12		
Adapter colour	Black			Black			Black		
Adapter height	33.2mm			33.2mm			33.2mm		

### Technical data

Rated voltage	24V DC	115V DC	230V DC	24V AC/DC	115V AC/DC	230V AC/DC	24V AC/DC	115V AC/DC	230V AC/DC
Circuit type	Led + Diode(1A)			Bipolar Led + Varistor			Bipolar Led + RC circuit		
Led colour	Red			Red			Red		

### Packaging

Qty/Bag	1pc / bag	1pc / bag	1pc / bag
---------	-----------	-----------	-----------

### Other accessories options

-
---



### Notes:

Adapter available with different led colour. Adapter available with different circuits.	Adapter available with different led colour. Adapter available with different circuits.	Adapter available with different led colour. Adapter available with different circuits.
--	--	--



## VALVE CONNECTORS

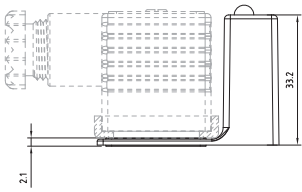
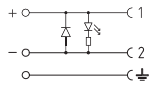
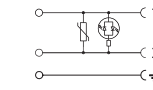
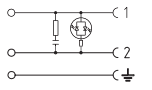

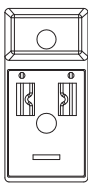
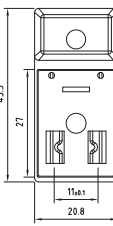
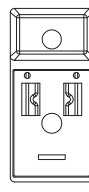
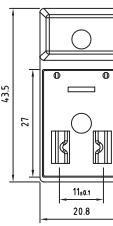
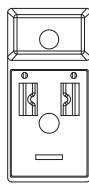
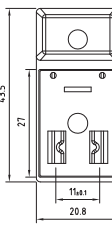
Technical drawing												
												
												
Product description												
Connector type	Adapter base for DIN valve connectors			Adapter base for DIN valve connectors			Adapter base for DIN valve connectors					
Conforms to	Industrial			Industrial			Industrial					
Construction type	B			B			B					
Part number (P.E. H.6)	<b>AM1N02DL1A AM1N02DL2A AM1N02DL3A</b>			<b>AM1N02VL1A AM1N02VL2A AM1N02VL3A</b>			<b>AM1N02FL1A AM1N02FL2A AM1N02FL3A</b>					
Part number (P.E. H.12)	<b>AM1N02DL1B AM1N02DL2B AM1N02DL3B</b>			<b>AM1N02VL1B AM1N02VL2B AM1N02VL3B</b>			<b>AM1N02FL1B AM1N02FL2B AM1N02FL3B</b>					
Description	Rectangular angled 90° adapter AM1 series			Rectangular angled 90° adapter AM1 series			Rectangular angled 90° adapter AM1 series					
Contacts spacing	11mm			11mm			11mm					
Number of contacts	2poles + P.E.			2poles + P.E.			2poles + P.E.					
Earth positioning	H.6 or H.12			H.6 or H.12			H.6 or H.12					
Adapter colour	Black			Black			Black					
Adapter height	33.2mm			33.2mm			33.2mm					
Technical data												
Rated voltage	24V DC	115V DC	230V DC	24V AC/DC	115V AC/DC	230V AC/DC	24V AC/DC	115V AC/DC	230V AC/DC			
Circuit type	Led + Diode(1A)			Bipolar Led + Varistor			Bipolar Led + RC circuit					
Led colour	Red			Red			Red					
Packaging												
Qty/Bag	1pc / bag			1pc / bag			1pc / bag					
Other accessories options												
-												
Notes:												
Adapter available with different led colour.												
Adapter available with different circuits.												

## VALVE CONNECTORS



### Technical drawing

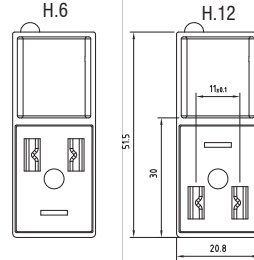
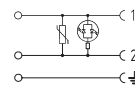
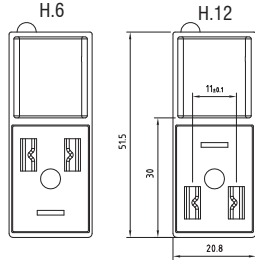
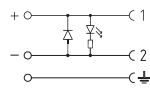
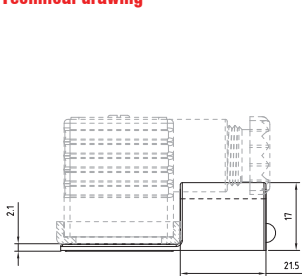

### Product description

Connector type	Adapter base for DIN valve connectors			Adapter base for DIN valve connectors		
Conforms to	Industrial			Industrial		
Construction type	B			B		
Part number (P.E. H.6)	<b>AM1N02DL1A-180</b>	<b>AM1N02DL2A-180</b>	<b>AM1N02DL3A-180</b>	<b>AM1N02VL1A-180</b>	<b>AM1N02VL2A-180</b>	<b>AM1N02VL3A-180</b>
Part number (P.E. H.12)	<b>AM1N02DL1B-180</b>	<b>AM1N02DL2B-180</b>	<b>AM1N02DL3B-180</b>	<b>AM1N02VL1B-180</b>	<b>AM1N02VL2B-180</b>	<b>AM1N02VL3B-180</b>
Description	Rectangular straight 180° adapter AM1 series			Rectangular straight 180° adapter AM1 series		
Contacts spacing	11mm			11mm		
Number of contacts	2poles + P.E.			2poles + P.E.		
Earth positioning	H.6 or H.12			H.6 or H.12		
Adapter colour	Black			Black		
Adapter height	33.2mm			33.2mm		

### Technical data

Rated voltage	24V DC	115V DC	230V DC	24V AC/DC	115V AC/DC	230V AC/DC
Circuit type	Led + Diode(1A)			Bipolar Led + Varistor		
Led colour	Red			Red		

### Packaging

Qty/Bag	1pc / bag	1pc / bag
---------	-----------	-----------

### Other accessories options

-
---

### Notes:

Adapter available with different led colour.  
Adapter available with different circuits.

## VALVE CONNECTORS



Technical drawing											
Product description											
Connector type	Adapter base for DIN valve connectors			Adapter base for DIN valve connectors			Adapter base for DIN valve connectors				
Conforms to	EN175301-803			EN175301-803			EN175301-803				
Construction type	C			C			C				
Part number	<b>AP1N02L01</b>	<b>AP1N02L02</b>	<b>AP1N02L03</b>	<b>AP1N02DL1</b>	<b>AP1N02DL2</b>	<b>AP1N02DL3</b>	<b>AP1N02VL1</b>	<b>AP1N02VL2</b>	<b>AP1N02VL3</b>		
Description	Square micro angled 90° adapter AP1 series			Square micro angled 90° adapter AP1 series			Square micro angled 90° adapter AP1 series				
Contacts spacing	8mm			8mm			8mm				
Number of contacts	2poles + 2P.E.			2poles + 2P.E.			2poles + 2P.E.				
Earth positioning	H.6-12			H.6-12			H.6-12				
Adapter colour	Black			Black			Black				
Adapter height	26mm			26mm			26mm				
Technical data											
Rated voltage	24V AC/DC	115V AC/DC	230V AC/DC	24V DC	115V DC	230V DC	24V AC/DC	115V AC/DC	230V AC/DC		
Circuit type	Bipolar Led			Led + Diode(1A)			Bipolar Led + Varistor				
Led colour	Red			Red			Red				
Packaging											
Qty/Bag	1pc / bag			1pc / bag			1pc / bag				
Other accessories options											
-											
Notes:											
Adapter available with different led colour.											
Adapter available with different circuits.											

## VALVE CONNECTORS



### Technical drawing

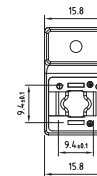
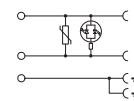
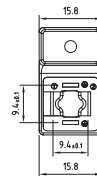
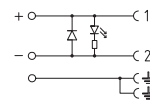
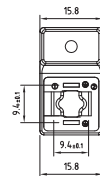
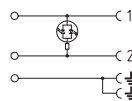
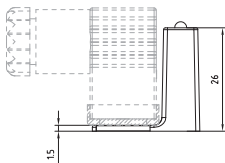

### Product description

Connector type	Adapter base for DIN valve connectors			Adapter base for DIN valve connectors			Adapter base for DIN valve connectors		
Conforms to	Industrial			Industrial			Industrial		
Construction type	C			C			C		
Part number	<b>AP2N02L01</b>	<b>AP2N02L02</b>	<b>AP2N02L03</b>	<b>AP2N02DL1</b>	<b>AP2N02DL2</b>	<b>AP2N02DL3</b>	<b>AP2N02VL1</b>	<b>AP2N02VL2</b>	<b>AP2N02VL3</b>
Description	Square micro angled 90° adapter AP2 series			Square micro angled 90° adapter AP2 series			Square micro angled 90° adapter AP2 series		
Contacts spacing	9.4mm			9.4mm			9.4mm		
Number of contacts	2poles + 2P.E.			2poles + 2P.E.			2poles + 2P.E.		
Earth positioning	H.6-12			H.6-12			H.6-12		
Adapter colour	Black			Black			Black		
Adapter height	26mm			26mm			26mm		

### Technical data

Rated voltage	24V AC/DC	115V AC/DC	230V AC/DC	24V DC	115V DC	230V DC	24V AC/DC	115V AC/DC	230V AC/DC
Circuit type	Bipolar Led			Led + Diode(1A)			Bipolar Led + Varistor		
Led colour	Red			Red			Red		

### Packaging

Qty/Bag	1pc / bag			1pc / bag			1pc / bag		
---------	-----------	--	--	-----------	--	--	-----------	--	--

### Other accessories options

-									
---	--	--	--	--	--	--	--	--	--

### Notes:

Adapter available with different led colour.  
Adapter available with different circuits.