



IN2CONNECT
ELECTRONIC CONNECTORS

SECTION 13

IP67 FIBER OPTIC INDUSTRIAL CONNECTORS

CONEC has developed an ODVA compatible IP67 Fiber Optic connection for harsh indoor and outdoor environment. The new system is a bayonet locking enclosure with integrated LC Duplex Connectors and Adapters. The bayonet locking enclosure provides an easy and secured connection also under adverse conditions. The available materials for the housings are plastic or nickel plated zinc die-cast for extreme harsh conditions.

The LC connections are available for single mode or multimode transmission, depending on the requirements of the operated system.

The major application for these connectors are connections from base stations to the transmission modules based on antenna poles or for network connections on the last mile into end users homes. This program is supplemented by preassembled patch cables in various lengths.



IN2CONNECT UK LTD
UNIT 5
HOME FARM
PETERSFIELD RD
ROPLEY
HAMPSHIRE
SO24 0EF

Tel: +44 (0)1962 773004

Email: sales@in2connect.uk.com
Website: www.in2connect.uk.com



For a variety of different Fiber Optic connections Conec supplies a wide range of Fiber Optic adapters.

To support different application requirements in regards to transmission Conec adapters are available with Phosphor-Bronze or ceramic sleeves for precise positioning of the connector ferrules to each other.

Adapters are available in both, plastic or zinc die-cast housing. The adapters are offered in simplex and duplex configurations. For installation of the Fiber Optic adapters Conec offers a stainless steel clip for push-in installation or adapters with integrated threads for simple fastening by screws.

All CONEC Fiber Optic Adapters are supplied with preinstalled dust caps.



IP67 Fiber Optic Industrial Duplex LC Connector

Receptacle Assembly Kit – Bayonet locking – Plastic or Zinc die-cast

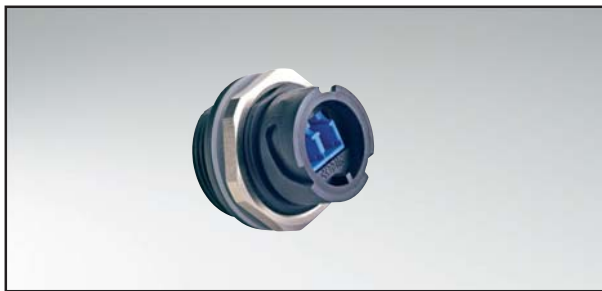

RoHS compliant

Description

- Industrial version with bayonet coupling
- For front or rear panel mount to a max. panel thickness of 3,2 mm
- Receptacle housing: Black plastic UL 94 V-0, zinc die-cast
- Protection cap: Black plastic, zinc die-cast nickel plated
- Available as a set with protection cap
- Operating temperature: -40°C to +85°C

Product drawing

Recommended Panel Cut-out for plastic version

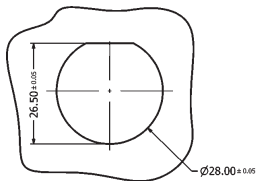

for metal version

Single-D Panel Cut-out

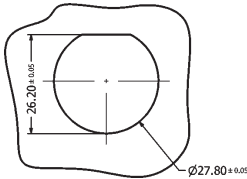

Double-D Panel Cut-out

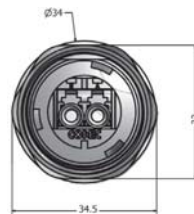
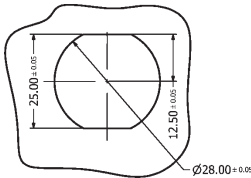

Protection cap plastic

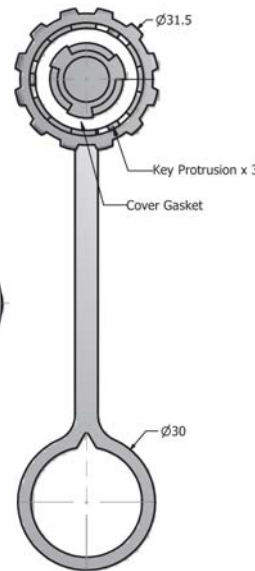

Protection cap metal

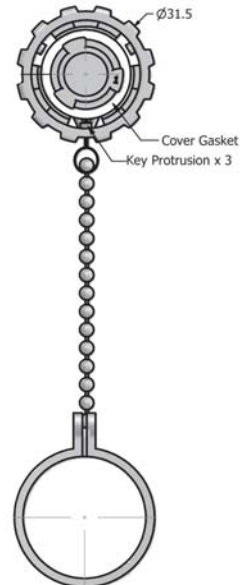

Order data

Type	Material	Surface	SM/MM/APC SM	Protection cap	Part Number
Receptacle Assembly Kit	Plastic	black	Single Mode		17-300010
Receptacle Assembly Kit	Plastic	black	Multi Mode		17-300020
Receptacle Assembly Kit	Plastic	black	APC Single Mode		17-300170
Receptacle Assembly Kit	Plastic	black	Single Mode	with protection cap	17-300230
Receptacle Assembly Kit	Plastic	black	Multi Mode	with protection cap	17-300240
Receptacle Assembly Kit	Plastic	black	APC Single Mode	with protection cap	17-300250
Receptacle Assembly Kit	Zinc die cast	nickel plated	Single Mode		17-300060
Receptacle Assembly Kit	Zinc die cast	nickel plated	Multi Mode		17-300070
Receptacle Assembly Kit	Zinc die cast	nickel plated	APC Single Mode		17-300180
Receptacle Assembly Kit	Zinc die cast	nickel plated	Single Mode	with protection cap	17-300380
Receptacle Assembly Kit	Zinc die cast	nickel plated	Multi Mode	with protection cap	17-300390
Receptacle Assembly Kit	Zinc die cast	nickel plated	APC Single Mode	with protection cap	17-300400

IP67 FIBER OPTIC INDUSTRIAL DUPLEX LC CONNECTOR

Inline coupler – on both sides Bayonet termination – Plastic



RoHS compliant

DESCRIPTION

- For front- or rear panel mounting up to wall thickness of .130"/3.2 mm
- Design: Black plastic
- Available as a set with protection cap
- Operating temperature: -40°C to +85°C

PRODUCT DRAWING

Recommended Panel Cut-out

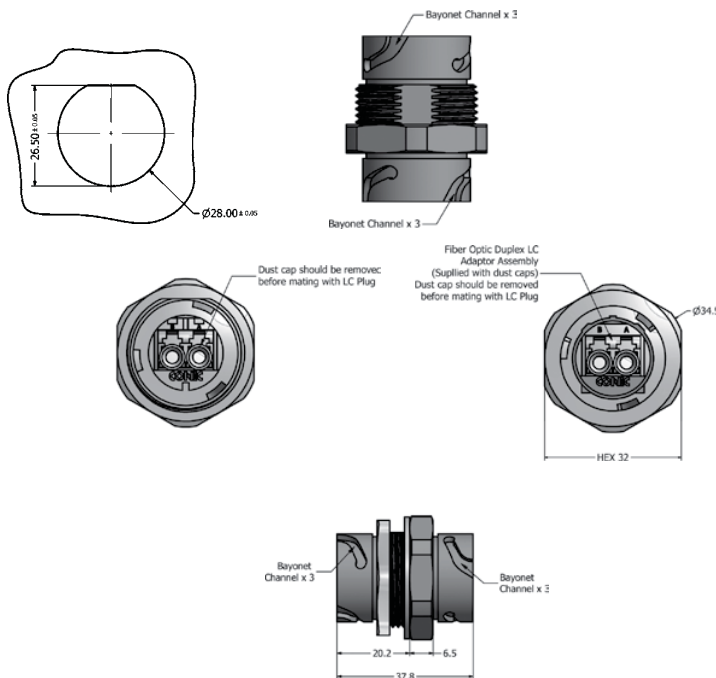

Protection cap plastic

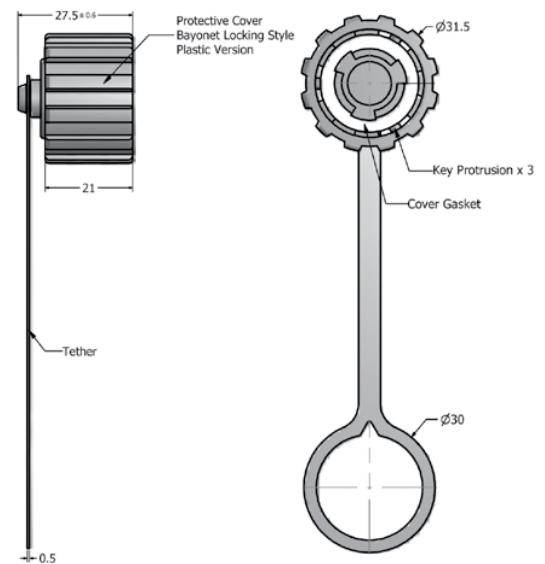

ORDER DATA

Type	Material	Surface	SM/MM/APC SM	Protection cap	Part Number
Inline coupler	Plastic	black	Single Mode		17-300790
Inline coupler	Plastic	black	Multi Mode		17-300800
Inline coupler	Plastic	black	APC Single Mode		17-300810
Inline coupler	Plastic	black	Single Mode	with protection cap	17-300820
Inline coupler	Plastic	black	Multi Mode	with protection cap	17-300830
Inline coupler	Plastic	black	APC Single Mode	with protection cap	17-300840

IP67 FIBER OPTIC INDUSTRIAL DUPLEX LC CONNECTOR

Plug Kit



RoHS compliant

DESCRIPTION

- Industrial version with bayonet coupling
- Connector: Black plastic UL 94 V-0, zinc die-cast
- Available as a set with protection cap
- Operating temperature: -40°C to +85°C

PRODUCT DRAWING

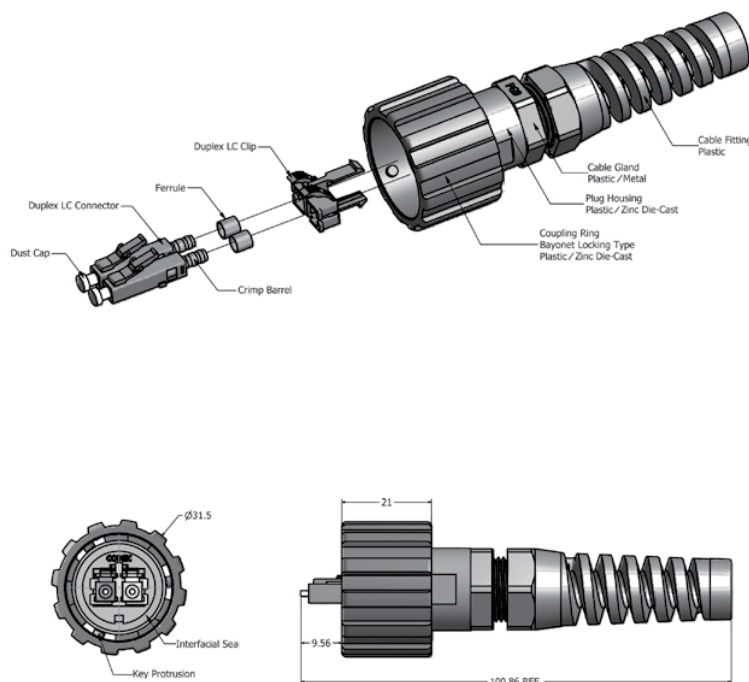

Protection cap plastic

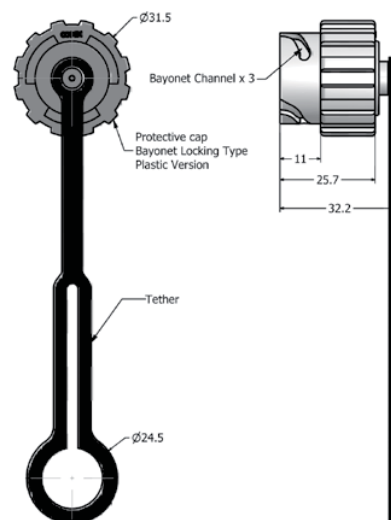

ORDER DATA

Type	Material	Surface	SM/MM/APC SM	Protection cap	Part Number
Plug Kit	Plastic	black	Single Mode		17-300030
Plug Kit	Plastic	black	Multi Mode		17-300040
Plug Kit	Plastic	black	APC Single Mode		17-300110
Plug Kit	Plastic	black	Single Mode	with protection cap	17-300200
Plug Kit	Plastic	black	Multi Mode	with protection cap	17-300210
Plug Kit	Plastic	black	APC Single Mode	with protection cap	17-300220
Plug Kit	Zinc die cast	nickel plated	Single Mode		17-300080
Plug Kit	Zinc die cast	nickel plated	Multi Mode		17-300090
Plug Kit	Zinc die cast	nickel plated	APC Single Mode		17-300120
Plug Kit	Zinc die cast	nickel plated	Single Mode	with protection cap	17-300410
Plug Kit	Zinc die cast	nickel plated	Multi Mode	with protection cap	17-300420
Plug Kit	Zinc die cast	nickel plated	APC Single Mode	with protection cap	17-300430
Protective cover	Plastic	black			17-300050

IP67 FIBER OPTIC INDUSTRIAL DUPLEX LC PATCH CORD

IP67 Industrial to IP67 Industrial Duplex LC

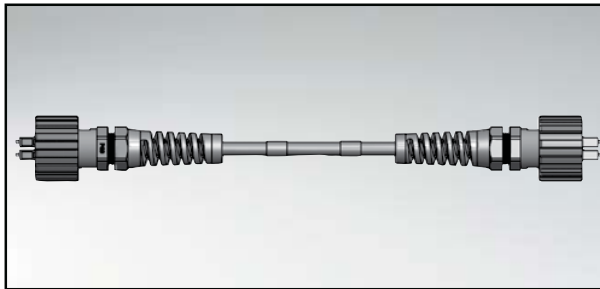

RoHS compliant

DESCRIPTION

- Single Mode, Multi Mode and Single Mode APC
- Multi Mode: maximum connector insertion loss (ILI): 0.5 dB, plus cable attenuation of 3.5 dB/km AT 850nm
- Single Mode: maximum connector insertion loss (il): 0.2 db, plus cable attenuation of 0.78 db/km at 1310nm
- Cables are indoor and outdoor OFNR type
- Plug protective cover (2x)
- Other lengths on request

PRODUCT DRAWING

Single Mode
Multi Mode
Single Mode APC

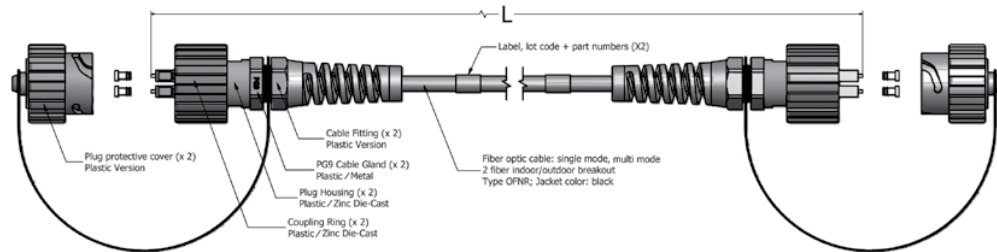

ORDER DATA

Type	Material	surface	SM/MM/APC SM	Length L	Part Number
Patch cord	Plastic	black	Single Mode	2 m	17-300320-02
Patch cord	Plastic	black	Single Mode	5 m	17-300320-05
Patch cord	Plastic	black	Single Mode	10 m	17-300320-10
Patch cord	Plastic	black	Multi Mode	2 m	17-300190-02
Patch cord	Plastic	black	Multi Mode	5 m	17-300190-05
Patch cord	Plastic	black	Multi Mode	10 m	17-300190-10
Patch cord	Plastic	black	Single Mode APC	2 m	17-300340-02
Patch cord	Plastic	black	Single Mode APC	5 m	17-300340-05
Patch cord	Plastic	black	Single Mode APC	10 m	17-300340-10
Patch cord	Zinc die cast	nickel plated	Single Mode	2 m	17-300330-02
Patch cord	Zinc die cast	nickel plated	Single Mode	5 m	17-300330-05
Patch cord	Zinc die cast	nickel plated	Single Mode	10 m	17-300330-10
Patch cord	Zinc die cast	nickel plated	Multi Mode	2 m	17-300310-02
Patch cord	Zinc die cast	nickel plated	Multi Mode	5 m	17-300310-05
Patch cord	Zinc die cast	nickel plated	Multi Mode	10 m	17-300310-10
Patch cord	Zinc die cast	nickel plated	Single Mode APC	2 m	17-300350-02
Patch cord	Zinc die cast	nickel plated	Single Mode APC	5 m	17-300350-05
Patch cord	Zinc die cast	nickel plated	Single Mode APC	10 m	17-300350-10

IP67 FIBER OPTIC INDUSTRIAL DUPLEX LC PATCH CORD

IP67 Industrial to IP20

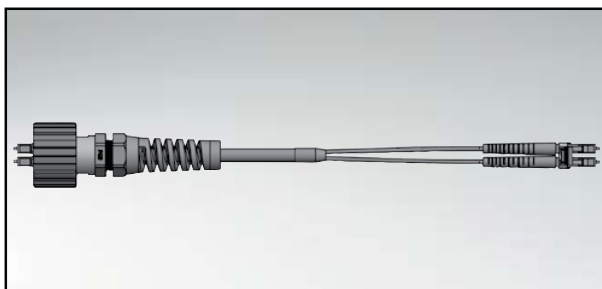

RoHS compliant

DESCRIPTION

- Single Mode, Multi Mode and Single Mode APC
- Multi Mode: maximum connector insertion loss (ILI): 0.5 dB, plus cable attenuation of 3.5 dB/km AT 850nm
- Single Mode: maximum connector insertion loss (il): 0.2 db, plus cable attenuation of 0.78 db/km at 1310nm
- protective cover shall be installed when unmated
- Other lengths on request

PRODUCT DRAWING

Single Mode
Multi Mode
Single Mode APC

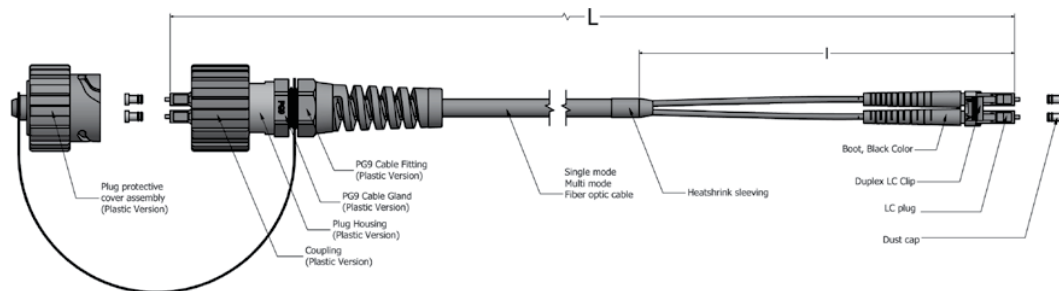

ORDER DATA

Type	Material	Surface	SM/MM/APC SM	Length L	Length I	Part Number
Patch cord	Plastic	black	Single Mode	1 m	0.10 m	17-300290-001
Patch cord	Plastic	black	Single Mode	30 m	2.66 m	17-300290-030
Patch cord	Plastic	black	Single Mode	60 m	2.66 m	17-300290-060
Patch cord	Plastic	black	Single Mode	100 m	2.66 m	17-300290-100
Patch cord	Plastic	black	Single Mode	200 m	2.66 m	17-300290-200
Patch cord	Plastic	black	Single Mode	300 m	2.66 m	17-300290-300
Patch cord	Plastic	black	Multi Mode	1 m	0.10 m	17-300300-001
Patch cord	Plastic	black	Multi Mode	30 m	2.66 m	17-300300-030
Patch cord	Plastic	black	Multi Mode	60 m	2.66 m	17-300300-060
Patch cord	Plastic	black	Multi Mode	100 m	2.66 m	17-300300-100
Patch cord	Plastic	black	Multi Mode	200 m	2.66 m	17-300300-200
Patch cord	Plastic	black	Multi Mode	300 m	2.66 m	17-300300-300
Patch cord	Plastic	black	Single Mode APC	1 m	0.10 m	17-300370-001
Patch cord	Plastic	black	Single Mode APC	30 m	2.66 m	17-300370-030
Patch cord	Plastic	black	Single Mode APC	60 m	2.66 m	17-300370-060
Patch cord	Plastic	black	Single Mode APC	100 m	2.66 m	17-300370-100
Patch cord	Plastic	black	Single Mode APC	200 m	2.66 m	17-300370-200
Patch cord	Plastic	black	Single Mode APC	300 m	2.66 m	17-300370-300

LC UNIBODY CONNECTOR

Singlemode – Multimode – Singlemode APC

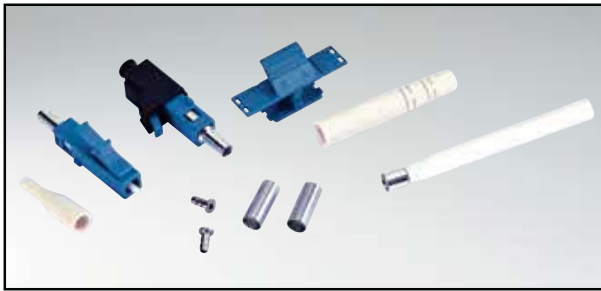

RoHS compliant

DESCRIPTION

- Housing material: Plastic (UL94V-0)
- Ferrule: Ceramic
- Temperature range: -40°C to +75°C
- Mating cycles: 1000
- Set with cable boot and crimp sleeve for cable Ø 2,0 mm
- Connector with Dust cap

PRODUCT DRAWING

Connector

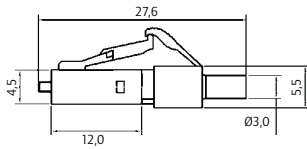

Crimp assembly 2.0

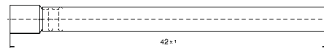

Crimp assembly 3.0

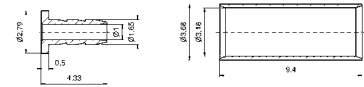

Duplex clip

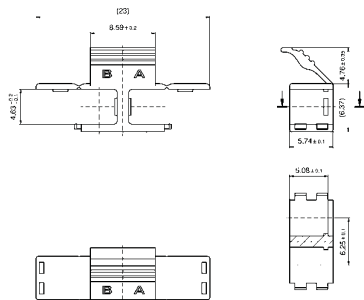

Boot for 2.0 & 3.0mm

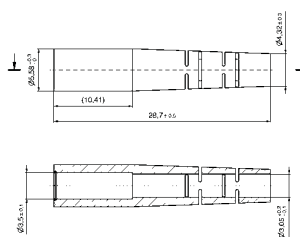

Boot for 0.9mm

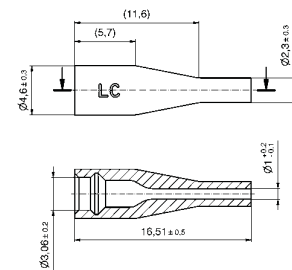

ORDER DATA

Type	SM/MM/APC	Color	Part Number
Connector with Dust cap	Single Mode	blue	18-000010
Connector with Dust cap	Multi Mode	beige	18-000020
Connector with Dust cap	Single Mode APC	green	18-000030
Crimp assembly for 2.0mm cables			18-000040
Crimp assembly for 3.0mm cables			18-000050
Duplex clip	Single Mode	blue	18-000100
Duplex clip	Multi Mode	beige	18-000110
Duplex clip	Single Mode APC	green	18-000120
Boot for 2.0 & 3.0mm cables		white	18-000080
Boot for 2.0 & 3.0mm cables		black	18-000090
Boot for 0.9mm fiber		white	18-000060
Boot for 0.9 mm fiber		black	18-000070

LC DUPLEX-ADAPTERS PLASTIC

Single Mode – Multi Mode – Single Mode APC



RoHS compliant

DESCRIPTION

- Housing material: Plastic (UL 94V-0)
- Sleeve: Ceramic, Phosphor-bronze
- Clip: Stainless steel
- Adapters are supplied with dust caps
- Adapter flange available with different mounting options: clip and screws

PRODUCT DRAWING

Adapter

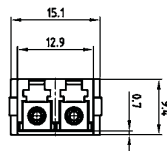
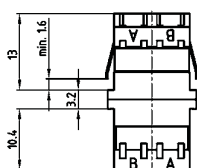

Panel cutout

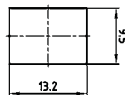

Wall thickness

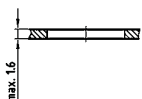

Adapter with flange

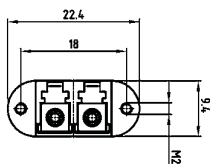
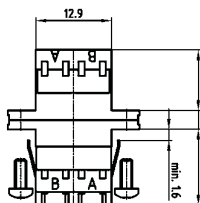

Panel cutout

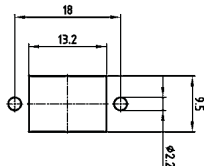

Adapter with shutter

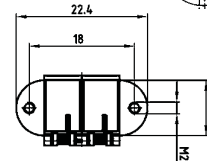
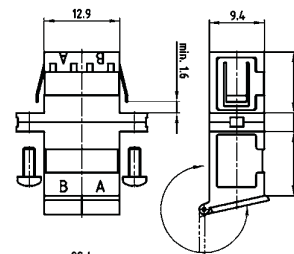

Panel cutout

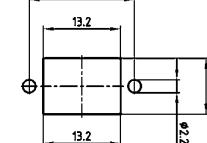

ORDER DATA

Type	Material sleeve	SM/MM/APC SM	Mount	Housing color	Part Number
Adapter	ceramic	Single Mode	Clip	blue	18-007900
Adapter	ceramic	Multi Mode	Clip	beige	18-007920
Adapter	phosphor-bronze	Multi Mode	Clip	beige	18-007940
Adapter	ceramic	APC 8°= Single Mode	Clip	green	18-007880
Adapter with flange	ceramic	Single Mode	M2x6 screw	blue	18-007980
Adapter with flange	ceramic	Multi Mode	M2x6 screw	beige	18-008000
Adapter with flange	phosphor-bronze	Multi Mode	M2x6 screw	beige	18-008020
Adapter with flange	ceramic	APC 8°= Single Mode	M2x6 screw	green	18-007960
Adapter with flange	ceramic	Single Mode	Clip	blue	18-008060
Adapter with flange	ceramic	Multi Mode	Clip	beige	18-008080
Adapter with flange	phosphor-bronze	Multi Mode	Clip	beige	18-008100
Adapter with flange	ceramic	APC 8°= Single Mode	Clip	green	18-008040
Adapter with shutter	ceramic	Single Mode	M2x6 screw	blue	18-008140
Adapter with shutter	ceramic	APC 8°= Single Mode	M2x6 screw	green	18-008120
Adapter with shutter	ceramic	Single Mode	Clip	blue	18-008180
Adapter with shutter	ceramic	APC 8°= Single Mode	Clip	green	18-008160

SC SIMPLEX-/DUPLEX-ADAPTERS PLASTIC

Single Mode – Multi Mode – Single Mode APC

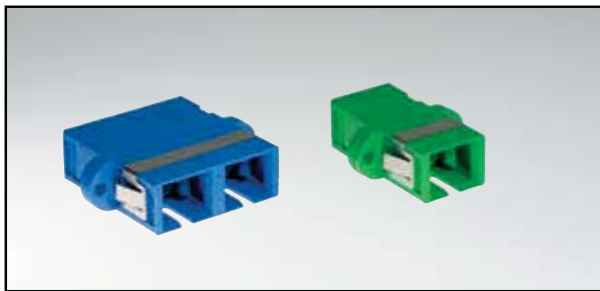

RoHS compliant

DESCRIPTION

- Housing material: Plastic (UL 94V-0)
- Sleeve: Ceramic, Phosphor-bronze
- Clip: Stainless steel
- Adapters are supplied with dust caps
- Mounting options: clip

PRODUCT DRAWING

Simplex-Adapter

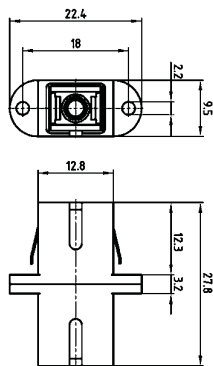

Duplex-Adapter

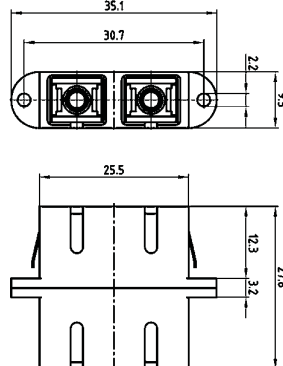

Panel cutout

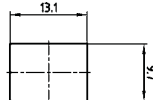

Panel cutout

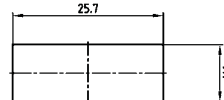

Wall thickness

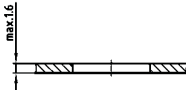

Wall thickness

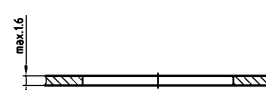

ORDER DATA

Type	Material sleeve	SM/MM/APC SM	Housing color	Part Number
Duplex adapter	ceramic	Single Mode	blue	18-007080
Duplex adapter	phosphor-bronze	Multi Mode	beige	18-007100
Duplex adapter	ceramic	APC 8°= Single Mode	green	18-007060
Simplex adapter	ceramic	Single Mode	blue	18-007020
Simplex adapter	phosphor-bronze	Multi Mode	beige	18-007040
Simplex adapter	ceramic	APC 8°= Single Mode	green	18-007000

SC SIMPLEX-/DUPLEX-ADAPTERS METAL

Single Mode – Multi Mode – Single Mode APC



RoHS compliant

DESCRIPTION

- Housing material: Zinc die-cast
- Sleeve: Phosphor-Bronze; Ceramic
- Clip: Stainless steel
- Adapters are supplied with dust caps
- Available with different mounting options: clip or screws

PRODUCT DRAWING

Simplex-Adapter

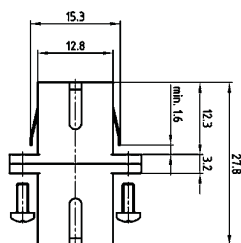

Duplex-Adapter

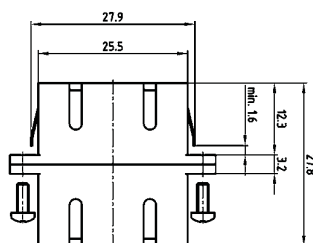

Panel cutout

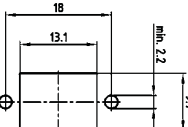

Panel cutout

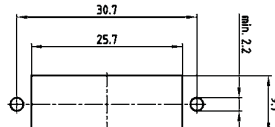

ORDER DATA

Type	Material sleeve	SM/MM/APC SM	Inner housing color	Mount	Part Number
Simplex adapter	ceramic	Single Mode	blue	M2x6 screw	18-007140
Simplex adapter	ceramic	Multi Mode	beige	M2x6 screw	18-007160
Simplex adapter	phosphor-bronze	Multi Mode	beige	M2x6 screw	18-007180
Simplex adapter	ceramic	APC 8°= Single Mode	green	M2x6 screw	18-007120
Simplex adapter	ceramic	Single Mode	blue	Clip	18-007220
Simplex adapter	ceramic	Multi Mode	beige	Clip	18-007240
Simplex adapter	phosphor-bronze	Multi Mode	beige	Clip	18-007260
Simplex adapter	ceramic	APC 8°= Single Mode	green	Clip	18-007200
Duplex adapter	ceramic	Single Mode	blue	M2x6 screw	18-007300
Duplex adapter	ceramic	Multi Mode	beige	M2x6 screw	18-007320
Duplex adapter	phosphor-bronze	Multi Mode	beige	M2x6 screw	18-007340
Duplex adapter	ceramic	APC 8°= Single Mode	green	M2x6 screw	18-007280
Duplex adapter	ceramic	Single Mode	blue	Clip	18-007380
Duplex adapter	ceramic	Multi Mode	beige	Clip	18-007400
Duplex adapter	phosphor-bronze	Multi Mode	beige	Clip	18-007420
Duplex adapter	ceramic	APC 8°= Single Mode	green	Clip	18-007360

ST SIMPLEX-/DUPLEX-ADAPTERS PLASTIC

Single Mode – Multi Mode



RoHS compliant

DESCRIPTION

- Housing material: Plastic (UL 94V-0)
- Sleeve: Ceramic, Phosphor-bronze
- Adapters are supplied with dust caps

PRODUCT DRAWING

Simplex-Adapter

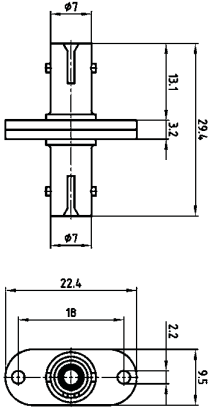

Duplex-Adapter

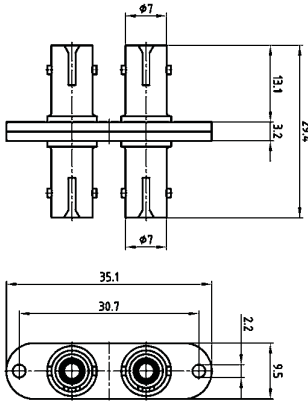

Panel cutout

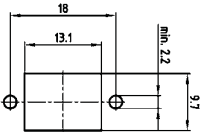

Panel cutout

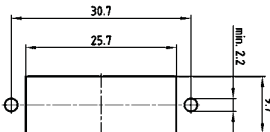

ORDER DATA

Type	Material sleeve	SM/MM	Housing color	Part Number
Simplex adapter	ceramic	Single Mode	blue	18-007680
Simplex adapter	phosphor-bronze	Multi Mode	beige	18-007700
Duplex adapter	ceramic	Single Mode	blue	18-007720
Duplex adapter	phosphor-bronze	Multi Mode	beige	18-007740

ST SIMPLEX-METAL ADAPTERS

Single Mode – Multi Mode



RoHS compliant

DESCRIPTION

- Housing material: Zinc die-cast, nickel plated
- Sleeve: Phosphor-Bronze; Ceramic
- Adapters are supplied with dust caps

PRODUCT DRAWING

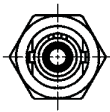
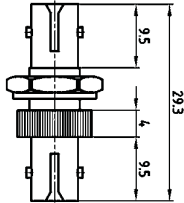

Panel cutout

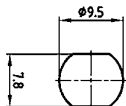

ORDER DATA

Type	Material sleeve	SM/MM	Housing material	Part Number
Simplex adapter	ceramic	Single Mode	zinc diecast	18-007760
Simplex adapter	ceramic	Multi Mode	zinc diecast	18-007780
Simplex adapter	phosphor-bronze	Multi Mode	zinc diecast	18-007800

FC SIMPLEX-/DUPLEX-ADAPTERS PLASTIC AND METAL

Single Mode – Multi Mode



RoHS compliant

DESCRIPTION

- Housing material: Plastic (UL 94V-0), zinc die-cast nickel plated
- FC-Duplex Adapter: Screws M2x6
- Sleeve: Ceramic, Phosphor-bronze
- Adapters are supplied with dust caps

PRODUCT DRAWING

Simplex-Adapter plastic

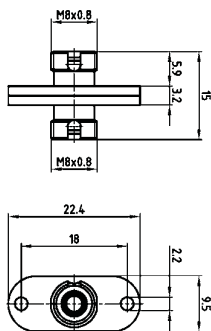

Panel cutout

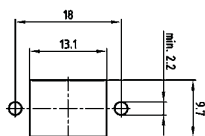

Simplex-Adapter metal

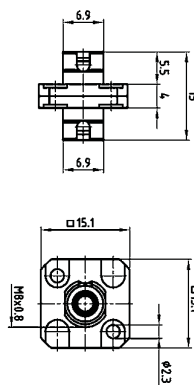

Panel cutout

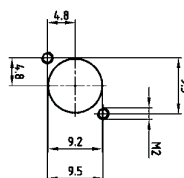

Duplex-Adapter metal

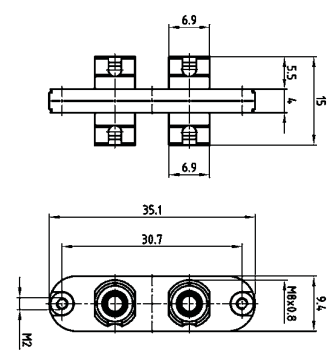

Panel cutout

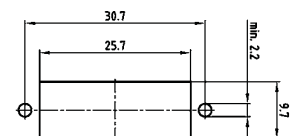

ORDER DATA

Type	Material sleeve	SM/MM	Housing color/ Housing material	Part Number
Simplex adapter plastic	ceramic	Single Mode	blue	18-007480
Simplex adapter plastic	phosphor-bronze	Multi Mode	beige	18-007500
Simplex adapter metal	ceramic	Single Mode	zinc die-cast	18-007540
Simplex adapter metal	ceramic	Multi Mode	zinc die-cast	18-007560
Simplex adapter metal	phosphor-bronze	Multi Mode	zinc die-cast	18-007580
Duplex adapter metal	ceramic	Single Mode	zinc die-cast	18-007620
Duplex adapter metal	ceramic	Multi Mode	zinc die-cast	18-007640
Duplex adapter metal	phosphor-bronze	Multi Mode	zinc die-cast	18-007660

SC/ST SIMPLEX-/DUPLEX ADAPTERS PLASTIC AND METAL

Single Mode – Multi Mode

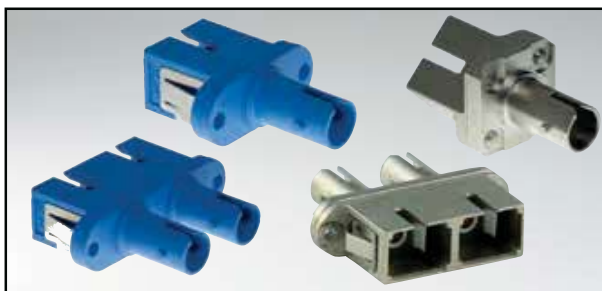

RoHS compliant

DESCRIPTION

- Housing material: Plastic (UL 94V-0) and zinc die-cast, nickel plated
- Sleeve: ceramic, phosphor-bronze
- Clip: Stainless steel
- Adapters are supplied with dust caps

PRODUCT DRAWING

Simplex-Adapter plastic

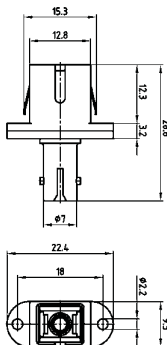

Duplex-Adapter plastic

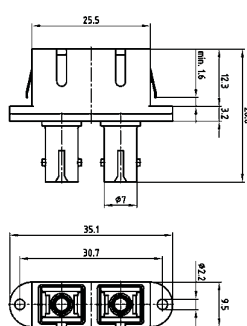

Simplex-Adapter metal

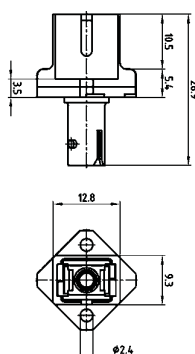

Duplex-Adapter metal

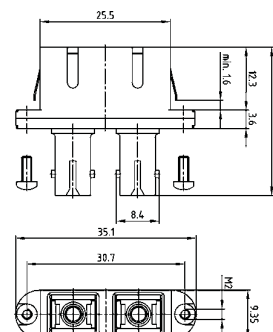

Panel cutout

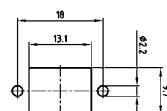

Panel cutout

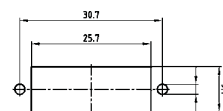

Panel cutout

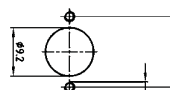

Panel cutout

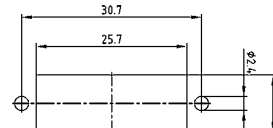

Wall thickness



Wall thickness

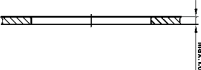

ORDER DATA

Type	Material sleeve	SM/MM	Inner housing color	Part Number
Simplex hybrid adapter plastic	ceramic	Single Mode	blue	18-010300
Simplex hybrid adapter plastic	phosphor-bronze	Multi Mode	beige	18-010320
Duplex hybrid adapter plastic	ceramic	Single Mode	blue	18-010340
Duplex hybrid adapter plastic	phosphor-bronze	Multi Mode	beige	18-010360
Simplex hybrid adapter metal	ceramic	Single Mode	blue	18-010500
Simplex hybrid adapter metal	ceramic	Multi Mode	beige	18-010520
Simplex hybrid adapter metal	phosphor-bronze	Multi Mode	beige	18-010540
Duplex hybrid adapter metal, M2x6	ceramic	Single Mode	blue	18-010380
Duplex hybrid adapter metal, M2x6	ceramic	Multi Mode	beige	18-010400
Duplex hybrid adapter metal, M2x6	phosphor-bronze	Multi Mode	beige	18-010420
Duplex hybrid adapter metal, clip	ceramic	Single Mode	blue	18-010440
Duplex hybrid adapter metal, clip	ceramic	Multi Mode	beige	18-010460
Duplex hybrid adapter metal, clip	phosphor-bronze	Multi Mode	beige	18-010480

FC/ST SIMPLEX-ADAPTERS METAL

Single Mode – Multi Mode



RoHS compliant

DESCRIPTION

- Housing material: zinc die-cast, nickel plated
- Sleeve: Ceramic, Phosphor-bronze
- Adapters are supplied with dust caps

PRODUCT DRAWING

Simplex-adapter Metal

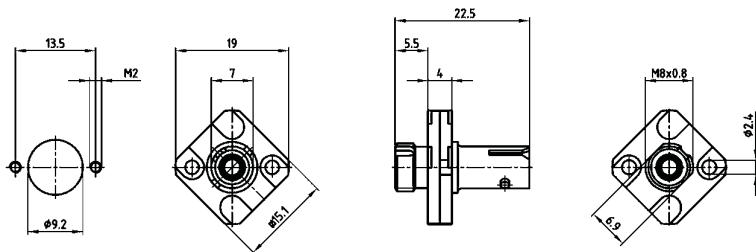

ORDER DATA

Type	Material sleeve	SM/MM	Housing material	Part Number
Simplex adapter metal	ceramic	Single Mode	zinc die-cast	18-010560
Simplex adapter metal	ceramic	Multi Mode	zinc die-cast	18-010580
Simplex adapter metal	phosphor-bronze	Multi Mode	zinc die-cast	18-010600