



GENERAL SPECIFICATIONS

RoHS COMPLIANT



All parts are currently manufactured with recommended materials to meet RoHS standards. All contacts have 50u" of nickel underplate, and a large selection of plating options: Pure tin matte, overall gold, or selective gold plating. For operating/processing temperature parameters, visit the RoHS section of our website, or refer to page 7 of this catalog.

MATERIALS (Consult factory for materials not shown.)

Insulator

- PBT, Valox*, Thermoplastic Polyester
- PPS, Ryton*, Polyphenylene Sulfide
- PEEK, Polyetheretherketone
- PA9T, High Temperature Polyamide

Contacts

- Phosphor Bronze (Standard)
- Beryllium Copper
- Beryllium Nickel
- Spinodal**
- Brass



Plating

Plating is Lead Free with Nickel Underplate, offered in Gold (Selective or Overall) and Pure Tin Overall.

UL/CUL File Number: E64287

CAGE CODE: 54453

ECCN: EAR99

INTERNATIONAL HARMONIZED CODE: 8536.69.4040

In2Connect UK Ltd

Tel: +44(0)1962 773004

Fax: +44(0)1962 600034

Sales@in2connect.uk.com

MECHANICAL

Board Insertion Force: 16 oz maximum per contact pair using .062" [1.57 mm] thick steel test blade.

Board Withdrawal Force: 1 oz minimum per contact pair using .062" [1.57 mm] thick steel test blade.

Special Insertion/Withdrawal forces available upon request.

ELECTRICAL

Insulation Resistance: 5,000 Megohms

Contact Centers: .039" [1 mm] .050" [1.27 mm] .100" [2.54 mm] .125" [3.18 mm] .150" [3.81 mm] .156" [3.96 mm]

Operating Voltage:	225 VAC	300 VAC	700 VAC	750 VAC	850 VAC	950 VAC
---------------------------	---------	---------	---------	---------	---------	---------

DWV:	675 VAC	900 VAC	2100 VAC	2250 VAC	2550 VAC	2850 VAC
-------------	---------	---------	----------	----------	----------	----------

Current Rating: 1 to 5 Amp per contact

Contact Resistance: 30 milli Ohms maximum at rated current (May vary per product series***)

ENVIRONMENTAL

Solvent resistance: Perchloroethylene, Freon 113, Freon 11, Trichloroethylene

Operating Temperature:	PBT	-65°C to +130°C	Phosphor Bronze	-65°C to +125°C
	PPS	-65°C to +200/220°C***	Beryllium Copper	-65°C to +150°C
	PA9T	-65°C to +150°C	Spinodal**	-65°C to +200°C
	PEEK	-65°C to +250°C***	Beryllium Nickel***	-65°C to +300°C

(Continuous temperatures, higher for short duration. Contact factory for details.)

* Or equivalent

** Consult factory for special soldering guidelines.

*** Consult factory for more details.



PART NUMBER OPTIONS

MATERIALS (Insulator/Contact)

E = PBT & Phosphor Bronze
 Operating Temperature: -65°C To +125°C
 Processing Temperature: Wave only

R = PPS & Phosphor Bronze
 Operating Temperature: -65°C To +125°C
 Processing Temperature: 260°C Max. For 20 Sec.

G = PA9T & Phosphor Bronze
 Operating Temperature: -65°C To +125°C
 Processing Temperature: 260°C Max. For 20 Sec.

H = PBT & Beryllium Copper
 Operating Temperature: -65°C To +125°C
 Processing Temperature: Wave only

A = PPS & Beryllium Copper
 Operating Temperature: -65°C To +150°C
 Processing Temperature: 260°C Max. For 20 Sec.

J = PA9T & Beryllium Copper
 Operating Temperature: -65°C To +150°C
 Processing Temperature: 260°C Max. For 20 Sec.

M = White PA9T & Beryllium Copper
 Operating Temperature: -65°C To +150°C
 Processing Temperature: 260°C Max. For 20 Sec.

T = PPS & Beryllium Copper (Special, Consult Factory)
 Operating Temperature: -65°C To +175°C
 Processing Temperature: 260°C Max. For 20 Sec.

***F** = PPS & Spinodal** (Consult Factory)
 Operating Temperature: -65°C To +200°C

***C** = PPS & Beryllium Nickel (Consult Factory)
 Operating Temperature: -65°C To +200°C
 Processing Temperature: 260°C Max. For 20 Sec.

W = PEEK & Beryllium Nickel (Consult Factory)
 Operating Temperature: -65°C To +250°C
 Processing Temperature: 260°C Max. For 20 Sec.
 (Available with 'M' plating only.)

**Available with overall gold plating (S or M) only.
 **Consult factory for special soldering guidelines.*

CONTACT FINISH - RoHS Compliant
All platings are Lead Free and have .000050" Nickel underplate

Contact Surface	Termination
B = .000010" Gold	.000100" Pure Tin, Matte
C = .000030" Gold	.000100" Pure Tin, Matte
G = .000010" Gold	.000005" Gold
Y = .000030" Gold	.000005" Gold
Contact Surface	Overall Plating
S = .000010" Gold	.000010" Gold
M = .000030" Gold	.000010" Gold
E = .000100" Pure Tin, Matte	.000100" Pure Tin, Matte

Overall Tin only available in E, R & G material codes

CONTACT CENTERS

E = 1.00 mm [.039"]	C = .100" [2.54 mm]
B = .050" [1.27 mm]	A = .125" [3.18 mm]
K = .078" [1.98 mm]	J = .150" [3.81 mm]
*N = .079" [2.00 mm]	M = .156" [3.96 mm]

*Consult factory.

NUMBER OF CONTACT POSITIONS
 See applicable specification page

READOUT

D = Dual
 D = Dual Row/ Crimp to Center for Single Readout
 F = Dual Edge
 H = Half Loaded
 M = Male Card Edge

Registered Trademarks

Sabic Innovative Plastics: Valox	Sullins Electronics: Zero Lead Time
Phillips 66: Ryton	Sullins Electronics: Sullins
Gardner-Denver Co.: Wire Wrap	Underwriters Labs: UL
RTP Compounder: PEEK	Ametek: Spinodal

MODIFICATION CODE (Consult Factory)
 OMIT FOR STANDARD

MOUNTING STYLE

H = Clearance Holes, .125" [3.18 mm] Diameter
 N = No Mounting
 S = Side Mounting, .125" [3.18 mm] Diameter
 I = #4-40 Threaded Insert
 A = #4-40 Threaded Insert in Side Holes
 F = Floating Bobbin
 W = .430" Ears, Flush Mounting, .125" [3.18 mm] Diameter
 D = .250" Ears, Flush Mounting, .125" [3.18 mm] Diameter
 P = Clearance Holes, .142" [3.61 mm] Diameter
 B = Open Card Slot
 X = .430" Ears, Flush Mounting, #4-40 Threaded Insert
 T = .250" Ears, Flush Mounting, #4-40 Threaded Insert
 V = .250" Ears, Flush, Side Mounting, #4-40 Threaded Insert
 Q = Straddle Mount
 Z = .250" Ears, Flush, Side Mounting, .125" [3.18 mm] Diameter
 R = Metal Board Lock

TERMINATION TYPE

Card Extender
 HR = .050" & 1 mm Contact Centers
 KR, KN, PN, PR = .025" [0.64 mm] Square Post

Dip Solder - High Profile
 RS = .025" [0.64 mm] Square Tail, Loop Bellows
 CS, PD, PF, PS, SC = .025" [0.64 mm] Square Tail, Hairpin Bellows
 CK, TK = .025" [0.64 mm] Round Tail, Loop Bellows
 CT, CW = .015" [0.38] X .025" [0.64] Tail, Hairpin Bellows
 HH = .050" & 1 mm [.039"] Contact Centers
 HL, HN = .050" Contact Centers
 KS, KD = .025" [0.64 mm] Square Post, Cantilever

Dip Solder - Low Profile
 SX, SU = Crimp to Center for Single Readout
 RT, RK, RY = .140" [3.56 mm] Row Spacing
 RX, RF, RU, RP = .200" [5.08 mm] Row Spacing
 RJ = .250" [6.35 mm] Row Spacing

Eyelet
 RE, TE, SE = Eyelet Tail

Press Fit

.200"[5.08 mm] Row Spacing	.100"[2.54 mm] Row Spacing
JB = .025" [0.64 mm] Sq. Post	JF = .025" [0.64 mm] Sq. Post
JC = .025" [0.64 mm] Sq. Post	JG = .025" [0.64 mm] Sq. Post
JW = .025" [0.64 mm] Sq. Post	JY = .025" [0.64 mm] Sq. Post
JX = .025" [0.64 mm] Sq. Post	JZ = .025" [0.64 mm] Sq. Post

Right Angle
 TA, TB, TM = Loop Bellows
 CA, CB, CC, PU = Hairpin
 PB, PG, PE, PJ, PP = Hairpin
 KA, KE, KU, KJ = Cantilever
 HA, HB = .050" & 1 mm CC
 RA, SA = Full Bellows

Cantilever
 ET, EY = .100" CC Low Profile
 YH = .050" CC Thru Hole
 YR = .050" CC Card Extender
 YF = .050" CC SMT
 YY = .050" CC Right Angle
 YS = .050" CC Thru Hole

Surface Mount
 HF = Surface Mount, .050" & 1mm Contact Centers

Wire Wrap
 RM = .025" [0.64 mm] Square Post, Loop Bellows
 CM, MC, PM = .025" [0.64 mm] Square Post, Hairpin Bellows
 KK = .031" [0.79 mm] X .062" [1.58 mm] Post
 KL = .031" [0.79 mm] X .062" [1.58 mm] Post Twisted 90°
 KM = .025" [0.64 mm] Square Post, Cantilever
 WW = .045" [1.14 mm] Square Post

Bi-Level
 LR = Card Extender
 LT = Dip Solder
 KB = Right Angle

Dual Edge
 SL = Dual Edge

Male Card Edge
 MW, MS = Dip Solder
 MR, MN = Card Extender
 MM = Wire Wrap
 MA, MD, MJ, MK, MV, & MB = Right Angle

See page 139 for Micro Plastics brand part number options. Specifications are subject to change without notice.



Bi-Level High Density, .050" [1.27 mm] / .100" [2.54 mm] Contact Centers Card Extender, Dip Solder for .062" [1.57 mm] or .093" [2.36 mm] Mating PCB

SPECIFICATIONS

- .050" [1.27 mm] Contact Center Spacing can replace .100" [2.54 mm] Contact Center part to double the number of contacts within the same area
- Backwards Compatible with Daughter Card Side
- Accommodates .062" ± .008" [1.57 mm ± 0.20 mm] or .093" ± .008" [2.36 mm ± 0.20 mm] mating PCB
- Contact Material: Beryllium Copper or Phosphor Bronze
- Body Material: PA9T
- UL Flammability Rating: 94V-0
- 3 Amps current rating for one contact energized
- High power-per-inch
- Voltage Rating: 225 VAC Minimum at sea level
- Consult Factory for PC board layouts/technical drawings

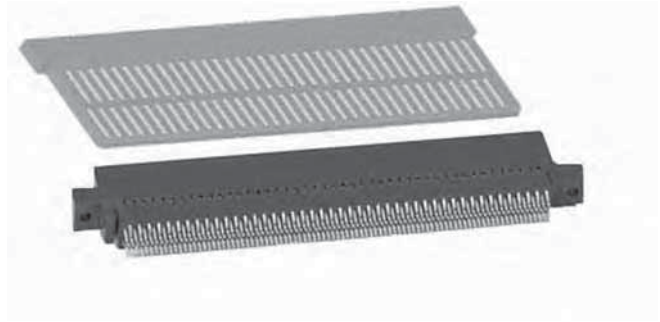

DIMENSIONS Dimensions in [] are in millimeters, all others are in inches.

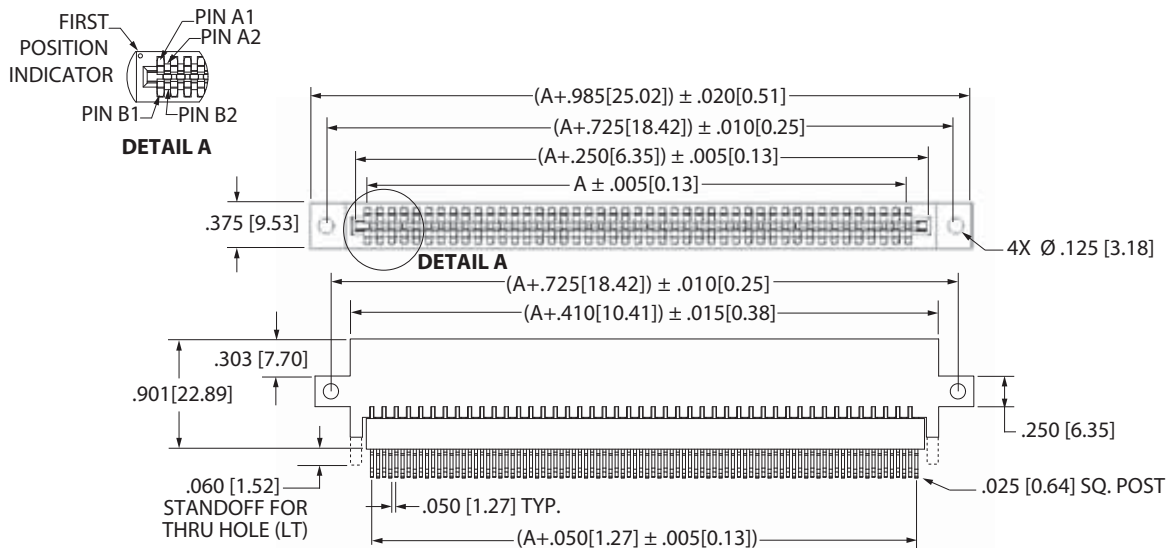

DAUGHTER CARD LAYOUT (1)

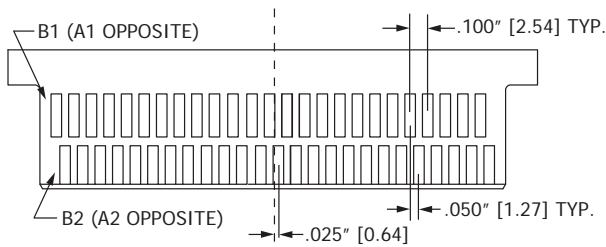

DAUGHTER CARD LAYOUT 1
50 POSITION SHOWN

DAUGHTER CARD LAYOUT (2)

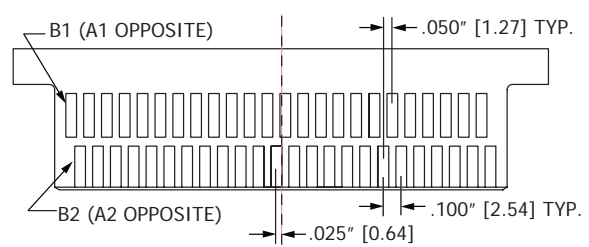

DAUGHTER CARD LAYOUT 2
48 POSITION SHOWN



Bi-Level High Density, .050" [1.27 mm] / .100" [2.54 mm] Contact Centers Card Extender, Dip Solder for .062" [1.57 mm] or .093" [2.36 mm] Mating PCB

Sullins Bi-Level

PART NUMBER OPTIONS

J C B 10 D LT H - Sxxxx

MATERIALS (INSULATOR/CONTACT)

- G = PA9T/Phosphor Bronze
- J = PA9T/Beryllium Copper

Refer to Page 7 for Operating/Processing Temperatures

CONTACT FINISH - RoHS Compliant

All platings are Lead Free and have .000050" Nickel underplate

Contact Surface

- B = .000010" Gold
- C = .000030" Gold
- Y = .000030" Gold

Termination

- .000100" Pure Tin, Matte
- .000100" Pure Tin, Matte
- .000005" Gold

CONTACT CENTERS

- B = .050" [1.27 mm] / .100" [2.54 mm]

MODIFICATION CODE (Consult Factory)
OMIT FOR STANDARD

- S1176 = For .093"±.008" [2.36 ± 0.20]
Thick Mating PCB

POSITIONS	DIMENSION A (See Opposite Page)			Daughter Card Layout
	No. of Contacts	in	mm	
06	12	0.200	5.08	1
08*	16	0.300	7.62	2
10	20	0.400	10.16	1
12	24	0.500	12.70	2
14*	28	0.600	15.24	1
16*	32	0.700	17.78	2
18*	36	0.800	20.32	1
20	40	0.900	22.86	2
22*	44	1.000	25.40	1
24	48	1.100	27.94	2
26*	52	1.200	30.48	1
28*	56	1.300	33.02	2
30	60	1.400	35.56	1
32*	64	1.500	38.10	2
34	68	1.600	40.64	1
36	72	1.700	43.18	2
38*	76	1.800	45.72	1
40	80	1.900	48.26	2
42	84	2.000	50.80	1
44	88	2.100	53.34	2
46*	92	2.200	55.88	1
48*	96	2.300	58.42	2
50	100	2.400	60.96	1
52	104	2.500	63.50	2
54*	108	2.600	66.04	1
56	112	2.700	68.58	2
58*	116	2.800	71.12	1
60	120	2.900	73.66	2
62*	124	3.000	76.20	1
64*	128	3.100	78.74	2
66*	132	3.200	81.28	1
68*	136	3.300	83.82	2
70	140	3.400	86.36	1
72	144	3.500	88.90	2
74*	148	3.600	91.44	1
76	152	3.700	93.98	2
78	156	3.800	96.52	1
80	160	3.900	99.06	2
82*	164	4.000	101.60	1
84*	168	4.100	104.14	2
86	172	4.200	106.68	1
88*	176	4.300	109.22	2
90	180	4.400	111.76	1
100	200	4.900	124.46	2
120†	240	5.900	149.86	2

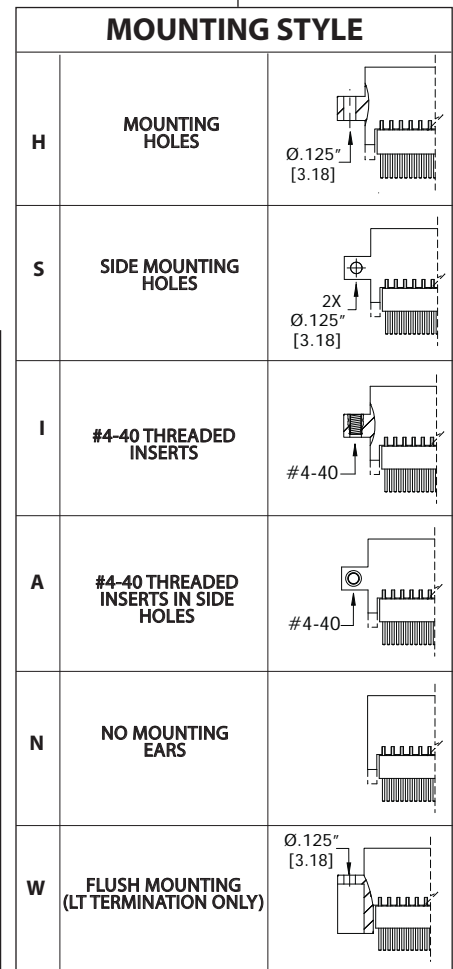
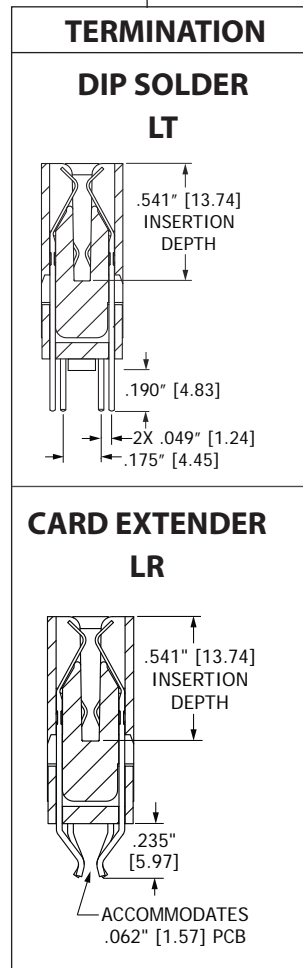

*Consult factory for availability. † Available in 'N' mounting only.



Bi-Level High Density, .050" [1.27 mm] / .100" [2.54 mm] Contact Centers Right Angle for .062" [1.57 mm] or .093" [2.36 mm] Mating PCB

U.S. Patent NO. US 6,790,054 B1

SPECIFICATIONS

- .050" [1.27 mm] Contact Center Spacing can replace .100" [2.54 mm] Contact Center parts to double the number of contacts within the same area
- Backwards Compatible with Daughter Card Side
- Accommodates .062" ± .008" [1.57 mm ± 0.20 mm] or .093" ± .008" [2.36 mm ± 0.20 mm] mating PCB
- Contact Material: Beryllium Copper or Phosphor Bronze
- Body Material: PA9T
- UL Flammability Rating: 94V-0
- 3 Amps current rating for one contact energized
- High power-per-inch
- Voltage Rating: 225 VAC Minimum at sea level
- Consult Factory for PC board layouts/technical drawings



TERMINATION TYPE

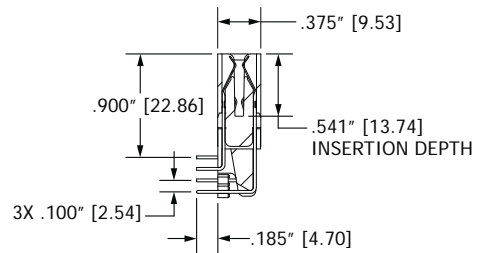

RIGHT ANGLE (KB)

DIMENSIONS

Dimensions in [] are in millimeters, all others are in inches.

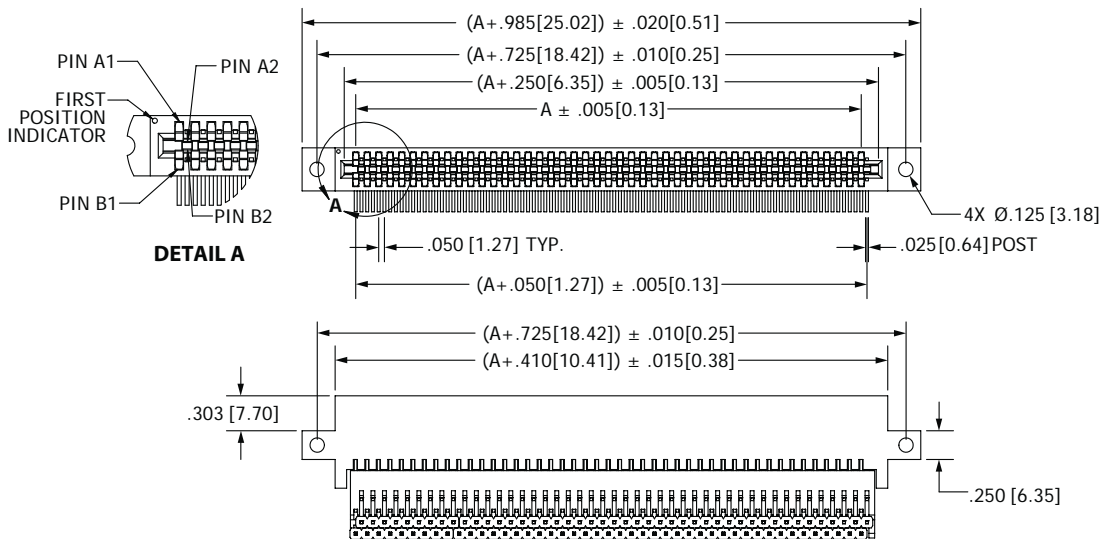

DAUGHTER CARD LAYOUT (1)

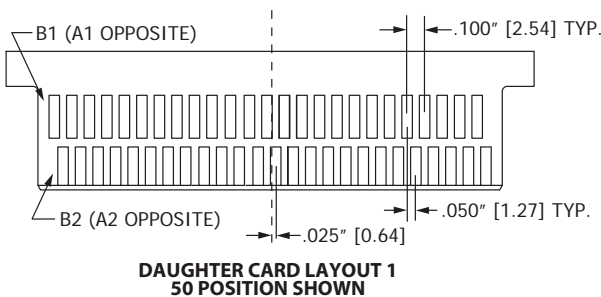

DAUGHTER CARD LAYOUT (2)

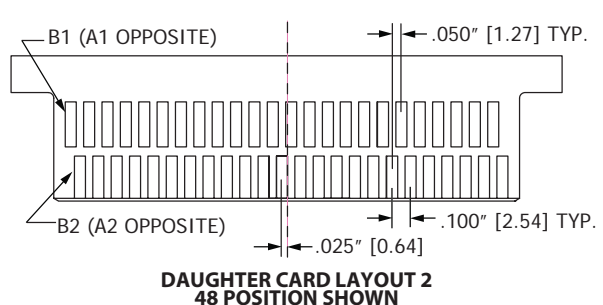



Bi-Level High Density, .050" [1.27 mm] / .100" [2.54 mm] Contact Centers

U.S. Patent NO. US 6,790,054 B1

Right Angle for .062" [1.57 mm] or .093" [2.36 mm] Mating PCB

Sullins Bi-Level

PART NUMBER OPTIONS

J C B 10 D KB S - Sxxxx

MATERIALS (INSULATOR/CONTACT)

- G = PA9T/Phosphor Bronze
- J = PA9T/Beryllium Copper
- Refer to Page 7 for Operating/Processing Temperatures

CONTACT FINISH - RoHS Compliant

All platings are Lead Free and have .000050" Nickel underplate

Contact Surface	Termination
B = .000010" Gold	.000100" Pure Tin, Matte
C = .000030" Gold	.000100" Pure Tin, Matte
Y = .000030" Gold	.000005" Gold

CONTACT CENTERS

B = .050" [1.27 mm] / .100" [2.54 mm]

OMIT FOR STANDARD

- S1176 = For .093"±.008" [2.36±0.20] Thick Mating PCB
- S1075 = Staggered Ears with Side Mounting Holes (Requires 'S' Mounting)
- S1076 = Staggered Ears with #4-40 Threaded Inserts (Requires 'A' Mounting)

POSITIONS	DIMENSION A (See Opposite Page)			Daughter Card Layout
	No. of Contacts	in	mm	
06	12	0.200	5.08	1
08*	16	0.300	7.62	2
10	20	0.400	10.16	1
12	24	0.500	12.70	2
14*	28	0.600	15.24	1
16*	32	0.700	17.78	2
18*	36	0.800	20.32	1
20	40	0.900	22.86	2
22*	44	1.000	25.40	1
24	48	1.100	27.94	2
26*	52	1.200	30.48	1
28*	56	1.300	33.02	2
30	60	1.400	35.56	1
32*	64	1.500	38.10	2
34	68	1.600	40.64	1
36	72	1.700	43.18	2
38*	76	1.800	45.72	1
40	80	1.900	48.26	2
42	84	2.000	50.80	1
44	88	2.100	53.34	2
46*	92	2.200	55.88	1
48*	96	2.300	58.42	2
50	100	2.400	60.96	1
52	104	2.500	63.50	2
54*	108	2.600	66.04	1
56	112	2.700	68.58	2
58*	116	2.800	71.12	1
60	120	2.900	73.66	2
62*	124	3.000	76.20	1
64*	128	3.100	78.74	2
66*	132	3.200	81.28	1
68*	136	3.300	83.82	2
70	140	3.400	86.36	1
72	144	3.500	88.90	2
74*	148	3.600	91.44	1
76	152	3.700	93.98	2
78	156	3.800	96.52	1
80	160	3.900	99.06	2
82*	164	4.000	101.60	1
84*	168	4.100	104.14	2
86	172	4.200	106.68	1
88*	176	4.300	109.22	2
90	180	4.400	111.76	1

MOUNTING STYLE		
H	MOUNTING HOLES	
S	SIDE MOUNTING HOLES	
I	#4-40 THREADED INSERTS	
A	#4-40 THREADED INSERTS IN SIDE HOLES	
N	NO MOUNTING EARS	

MODIFICATION CODE

(CONSULT FACTORY)

STAGGERED EARS WITH SIDE MOUNTING HOLES (-S1075)

STAGGERED EARS WITH #4-40 THREADED INSERTS (-S1076)

* Consult factory for availability.



SPECIFICATIONS

- .078" [1.98 mm] Contact Center Spacing can replace .156" [3.96 mm] Contact Center parts to double the number of contacts within the same area
- Backwards Compatible with Daughter Card Side
- Accommodates .062" ± .008" [1.57 mm ± 0.20 mm] PC board
- Contact Material: Beryllium Copper or Phosphor Bronze
- Body Material: PA9T
- UL Flammability Rating: 94V-0
- 3 Amps current rating for one contact energized
- High power-per-inch
- 75 grams minimum contact normal force
- Voltage Rating: 225 VAC Minimum at sea level
- Consult Factory for PC board layouts/technical drawings

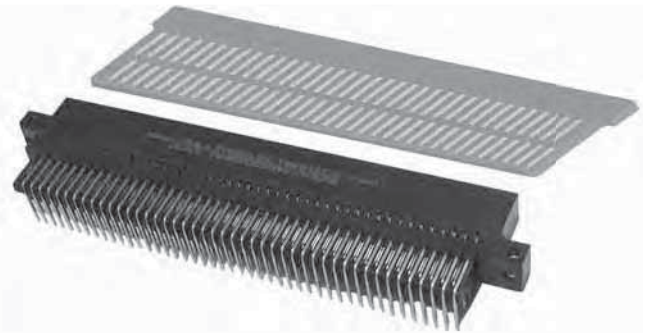

TERMINATION TYPE

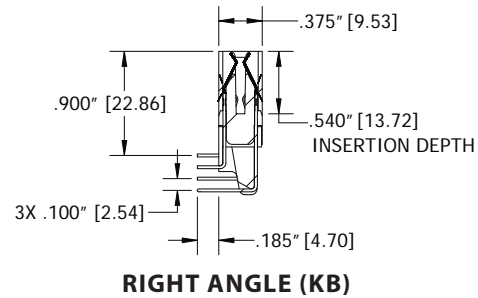

DIMENSIONS

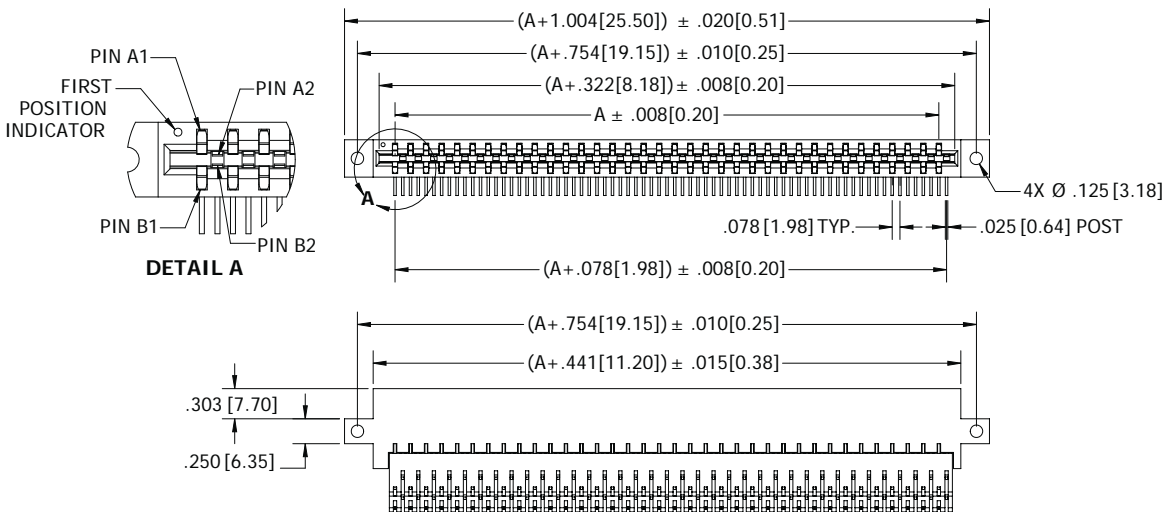
 Dimensions in [] are in millimeters, all others are in inches.

DAUGHTER CARD LAYOUT

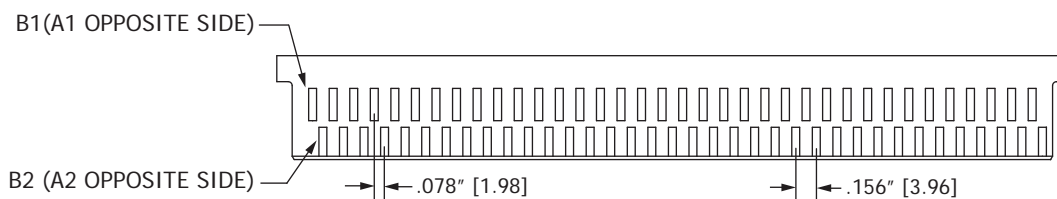

Sullins Bi-Level



Bi-Level, .078" [1.98 mm] / .156" [3.96 mm] Contact Centers High Density, Right Angle

U.S. Patent No. US 6,790,054 B1

PART NUMBER OPTIONS

J C K 10 D KB S - Sxxxx

MATERIALS (INSULATOR/CONTACT)

G = PA9T/Phosphor Bronze

J = PA9T/Beryllium Copper

Refer to Page 7 for Operating/Processing Temperatures

CONTACT FINISH - RoHS Compliant

All platings are Lead Free and have .000050" Nickel underplate

Contact Surface

B = .000010" Gold

C = .000030" Gold

Y = .000030" Gold

Termination

.000100" Pure Tin, Matte

.000100" Pure Tin, Matte

.000005" Gold

CONTACT CENTERS

K = .078" [1.98 mm] / .156" [3.96 mm]

OMIT FOR STANDARD

-S1075 = Staggered Ears with Side Mounting Holes (Requires 'S' Mounting)

-S1076 = Staggered Ears with #4-40 Threaded Inserts (Requires 'A' Mounting)

Sullins Bi-Level

POSITIONS	DIMENSION A (See Opposite Page)		
	No. of Contacts	in	mm
06*	12	0.312	7.92
08*	16	0.468	11.89
10*	20	0.624	15.85
12*	24	0.780	19.81
14*	28	0.936	23.77
16*	32	1.092	27.74
18*	36	1.248	31.70
20	40	1.404	35.66
22*	44	1.560	39.62
24*	48	1.716	43.59
26*	52	1.872	47.55
28*	56	2.028	51.51
30*	60	2.184	55.47
32*	64	2.340	59.44
34*	68	2.496	63.40
36*	72	2.652	67.36
38*	76	2.808	71.32
40*	80	2.964	75.29
42*	84	3.120	79.25
44*	88	3.276	83.21
46*	92	3.432	87.17
48*	96	3.588	91.14
50*	100	3.744	95.10
52*	104	3.900	99.06
54*	108	4.056	103.02
56*	112	4.212	106.98
58*	116	4.368	110.95
60*	120	4.524	114.91
62*	124	4.680	118.87
64*	128	4.836	122.83
66*	132	4.992	126.80
68*	136	5.148	130.76
70*	140	5.304	134.72
72*	144	5.460	138.68

MOUNTING STYLE		
H	MOUNTING HOLES	
S	SIDE MOUNTING HOLES	
I	#4-40 THREADED INSERTS	
A	#4-40 THREADED INSERTS IN SIDE HOLES	
N	NO MOUNTING EARS	

MODIFICATION CODE (CONSULT FACTORY)	
	STAGGERED EARS WITH SIDE MOUNTING HOLES (-S1075)
	STAGGERED EARS WITH #4-40 THREADED INSERTS (-S1076)

* Consult factory for availability.