



SECTION 1

ADVANCEDTCA CONNECTORS

This newly developed architecture and system layout allows manufacturers of telecom equipment a new standard for designing systems (PICMG 3.0). ATCA stands for: Advanced Telecommunications Computing Architecture

The basic structure is utilizing a modular concept. Application of this new structured approach allows various module designs that are compatible in layout and mechanical installation.

CONEC manufactured the power connectors for the ATCA-System which are used in Zone 1.

IN2CONNECT UK LTD
UNIT 5
HOME FARM
PETERSFIELD RD
ROPLEY
HAMPSHIRE
SO24 0EF

Tel: +44 (0)1962 773004

Email: sales@in2connect.uk.com
Website: www.in2connect.uk.com

Advanced TCA[®]





The PICMG Group created the PICMG 3.0 Standard. This Standard specifies the mechanical details with regards to input/output, voltage, current and connection parameters. Control, backplane layout and system architecture are part of the standard.

CONEC has developed a new family of connector products that adhere to this new Standard. Products such as plugs and sockets, high power and signal contacts, have been developed.

This new connector series is available with press fit and through hole contact types.

Product features:

- Rugged construction
- Polarizing system
- Premating contacts
- Press fit contacts ("Eye of the needle")
- Selective loading of contact positions
- Screwdown hardware
- Special variations on request

CONEC is member of the PICMG Group.
For more information please visit
www.picmg.com.



TECHNICAL DATA

Materials	Precision machined contacts	Stamped contacts
Insulator	Glass filled plastic, UL 94V-0	
Contacts		
Materials	Copper alloy	
Plating	Gold flash over nickel / 0.8 µm gold over nickel (press fit design tin plated)	Gold flash over nickel / 0.8 µm gold over nickel gold over nickel (press fit design tin plated)

Electrical Characteristics		
Max. current rating, per UL 1977, (see temperature rise curve for details)		
Size 16 power contacts	30 A continuous all contacts under load	
Size 22 signal contacts	2 A nominal rating	
Initial contact resistance (termination to termination)		
Size 16 power contacts	0.0022 Ω max.	
Size 22 signal contacts	0.0085 Ω max.	0.02 Ω max.
Insulation resistant	5 G Ω per IEC 512-2 Test 3a	
Voltage proof		
Contacts 1 through 16	1000 V r.m.s.	
Contacts 17 through 34	2000 V r.m.s.	
Creepage and clearance distance (minimum)		
Contact positions 1 through 16 to any other contact within this group	0.7 mm	
Contact positions 17 through 24 to any other contact within this group	2.5 mm	
Contact positions 25 through 34 to any other contact within this group	1.4 mm	
Contact positions 13 through 16 to 17 through 20	3.0 mm	
Contact positions 21 through 24 to 25, 26	4.0 mm	
Contact positions 25, 26 to 27 through 29	2.0 mm	
Working voltage	100 V r.m.s.	

Mechanical Characteristics	
Blind mating system	male and female connector bodies provide "lead-in" for 2.0 mm diametral misalignment
Polarization	provided by connector body design
Resistance to solder heat	260°C for 10 seconds duration per IEC 512-6, Test 12e 25-watt soldering iron (for other application contact factory)
Sequential contact mating system (succession)	<ol style="list-style-type: none"> 1. 25, 26, 28, 29, 30 and 31 2. 33 3. 34 4. contacts 1 to 24 mate before 27 and 32 (last mate)
Mechanical operations	250 cycles
Temperature range	-55°C to +125°C

Technical alterations are subjects to change without notice.

DIAGRAM

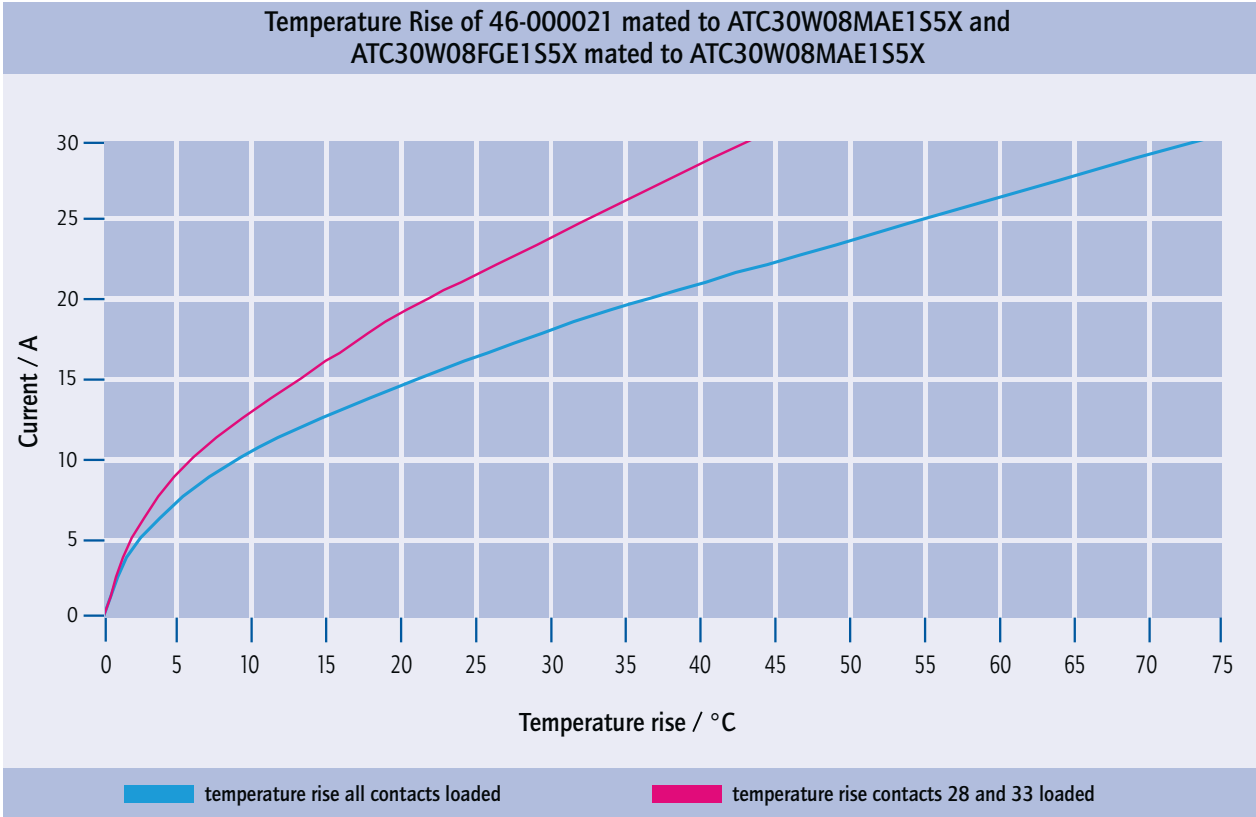

ADVANCEDTCA

Male Connector – angled – press fit – precision machined contacts

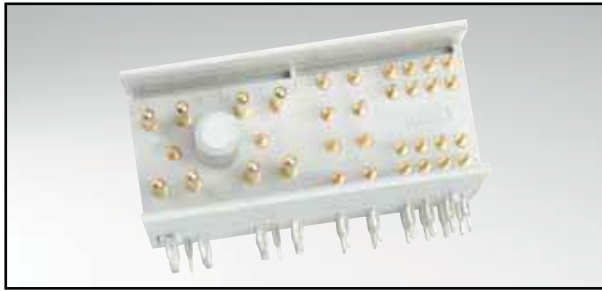

RoHS compliant – UL listed, File no.: E228329

DESCRIPTION

- Signal and power contacts
- Alternatively 22, 30 or 34 positions
- Eye of the needle press fit design, tin plated
- Precision machined contacts for mating area
- Mating area: gold plated quality class 1 or alternative quality class 3
- Special contact loadings possible on request

PRODUCT DRAWING

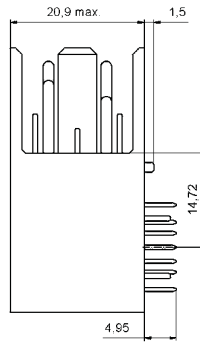
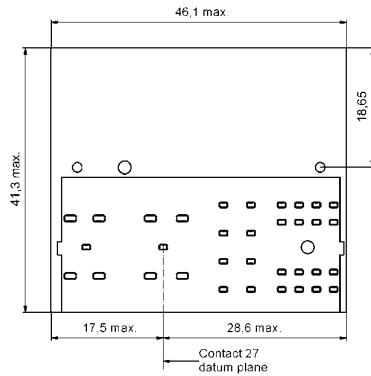

PCB-hole pattern (34 positions)

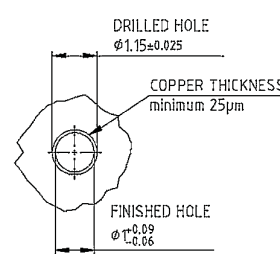
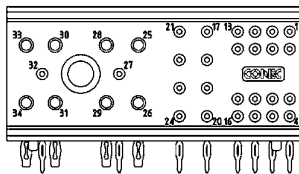
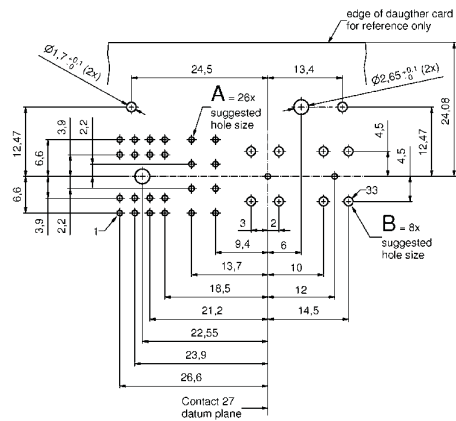

A (enlarged)

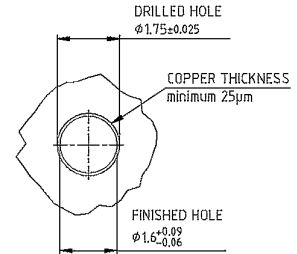

B (enlarged)

(Dim. = mm)

ORDER DATA

Number of positions	Contacts	Part number Quality class 3 (gold flash)	Part number Quality class 1 (0,8µm Au mating area)
22	14x signal / 8x power	ATC22 W08 MAE3S5 X	ATC22 W08 MAE1S5 X
30	22x signal / 8x power	ATC30 W08 MAE3S5 X	ATC30 W08 MAE1S5 X
34	26x signal / 8x power	ATC34 W08 MAE3S5 X	ATC34 W08 MAE1S5 X

ADVANCEDTCA

Female connector – straight – press fit – precision machined contacts

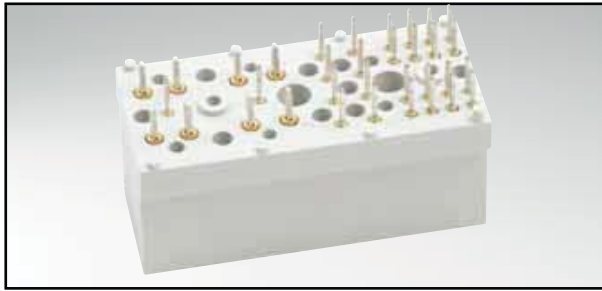

RoHS compliant – UL listed, File no.: E228329

DESCRIPTION

- Signal and power contacts
- Alternatively 22, 30 or 34 positions
- Eye of the needle press fit design, tin plated
- Precision machined contacts for mating area
- Mating area: gold plated quality class 1 or alternative quality class 3
- Special contact loadings possible on request

PRODUCT DRAWING

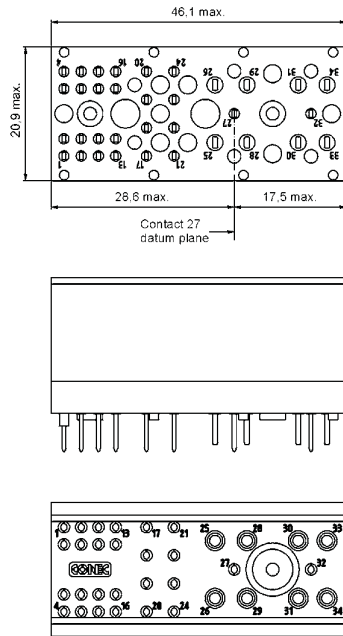

PCB-hole pattern (34 positions)

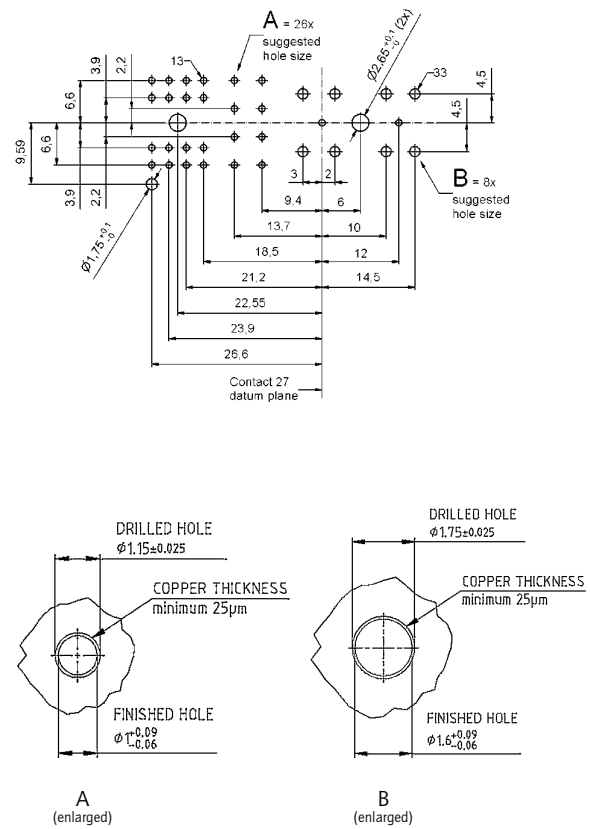

ORDER DATA

(Dim. = mm)

Number of positions	Contacts	Part number Quality class 3 (gold flash)	Part number Quality class 1 (0,8µm Au mating area)
22	14x signal / 8x power	ATC22 W08 FGE3S5 X	ATC22 W08 FGE1S5 X
30	22x signal / 8x power	ATC30 W08 FGE3S5 X	ATC30 W08 FGE1S5 X
34	26x signal / 8x power	ATC34 W08 FGE3S5 X	ATC34 W08 FGE1S5 X

ADVANCEDTCA

Male connector – angled – solder pin – precision machined contacts

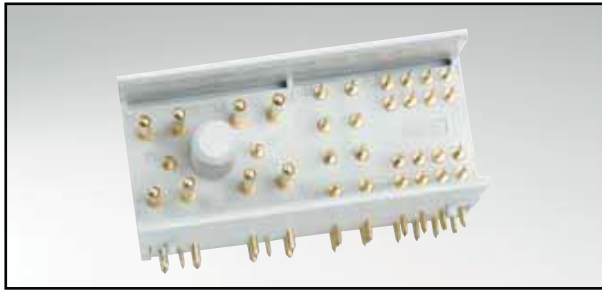

RoHS compliant – UL listed, File no.: E228329

DESCRIPTION

- Signal and power contacts
- Alternatively 22, 30 or 34 positions
- Mating area: gold plated quality class 1 or alternative quality class 3
- Special contact loadings possible on request

PRODUCT DRAWING

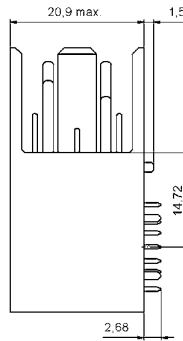
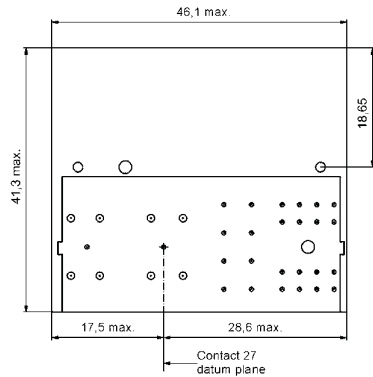

PCB-hole pattern (34 positions)

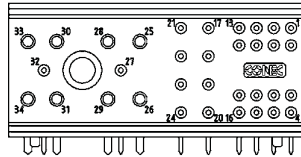
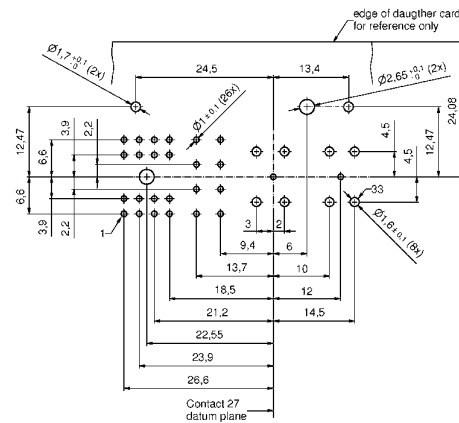

ORDER DATA

(Dim. = mm)

Number of positions	Contacts	Part number Quality class 3 (gold flash)	Part number Quality class 1 (0,8µm Au mating area)
22	14x signal / 8x power	ATC22 W08 MARAS5 X	ATC22 W08 MARCS5 X
30	22x signal / 8x power	ATC30 W08 MARAS5 X	ATC30 W08 MARCS5 X
34	26x signal / 8x power	ATC34 W08 MARAS5 X	ATC34 W08 MARCS5 X

ADVANCEDTCA

Female connector – straight – solder pin – precision machined contacts

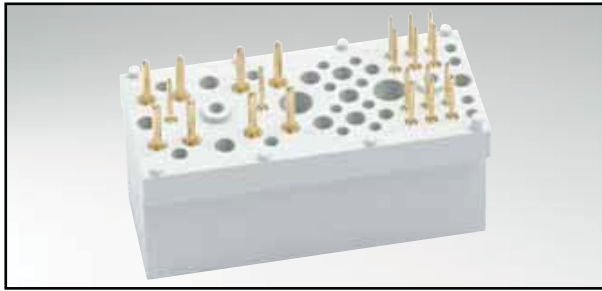

RoHS compliant – UL listed, File no.: E228329

DESCRIPTION

- Signal and power contacts
- Alternatively 22, 30 or 34 positions
- Mating area: gold plated quality class 1 or alternative quality class 3
- Special contact loadings possible on request

PRODUCT DRAWING

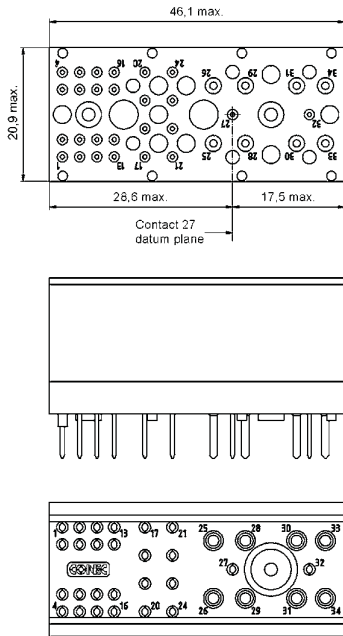

PCB-hole pattern (34 positions)

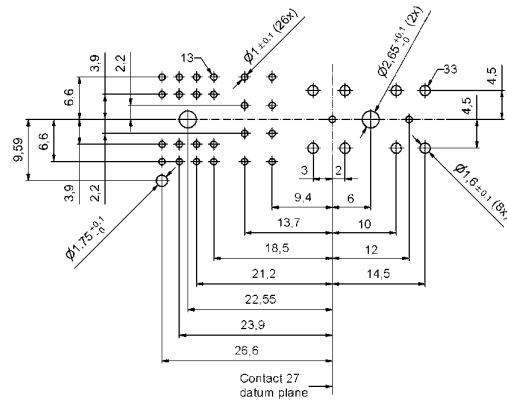

ORDER DATA

(Dim. = mm)

Number of positions	Contacts	Part number Quality class 3 (gold flash)	Part number Quality class 1 (0,8µm Au mating area)
22	14x signal / 8x power	ATC22 W08 FGRASS X	ATC22 W08 FGRC5 X
30	22x signal / 8x power	ATC30 W08 FGRASS X	ATC30 W08 FGRC5 X
34	26x signal / 8x power	ATC34 W08 FGRASS X	ATC34 W08 FGRC5 X

ADVANCEDTCA

Female connector – straight – press fit – stamped contacts

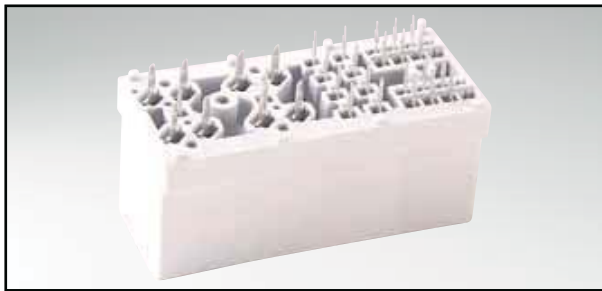

RoHS compliant

DESCRIPTION

- Signal and power contacts
- Alternatively 22, 30 or 34 positions
- Eye of the needle press fit design, tin plated
- Mating area: gold plated quality class 1 or alternative quality class 3
- Special contact loadings possible on request

PRODUCT DRAWING

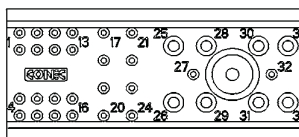
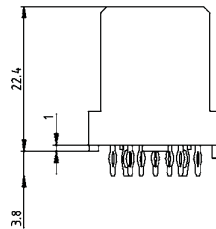
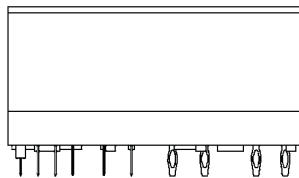
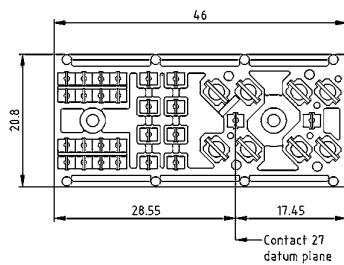

PCB-hole pattern (34 positions)

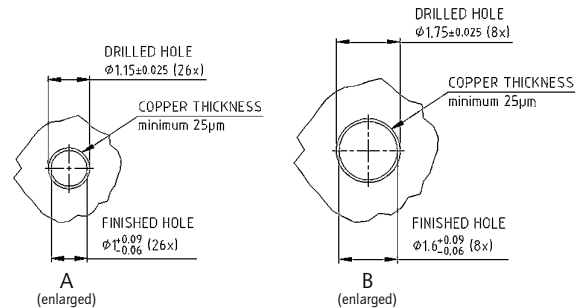
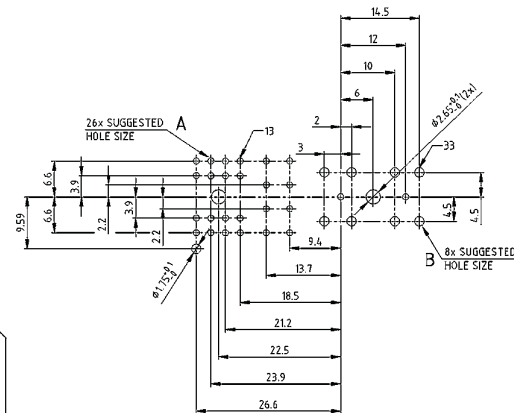

ORDER DATA

(Dim. = mm)

Number of positions	Contacts	Part number Quality class 3 (gold flash)	Part number Quality class 1 (0,8µm Au mating area)
22	14x signal / 8x power	46-000013	46-000011
30	22x signal / 8x power	46-000023	46-000021
34	26x signal / 8x power	46-000033	46-000031

Advanced TCA[®]

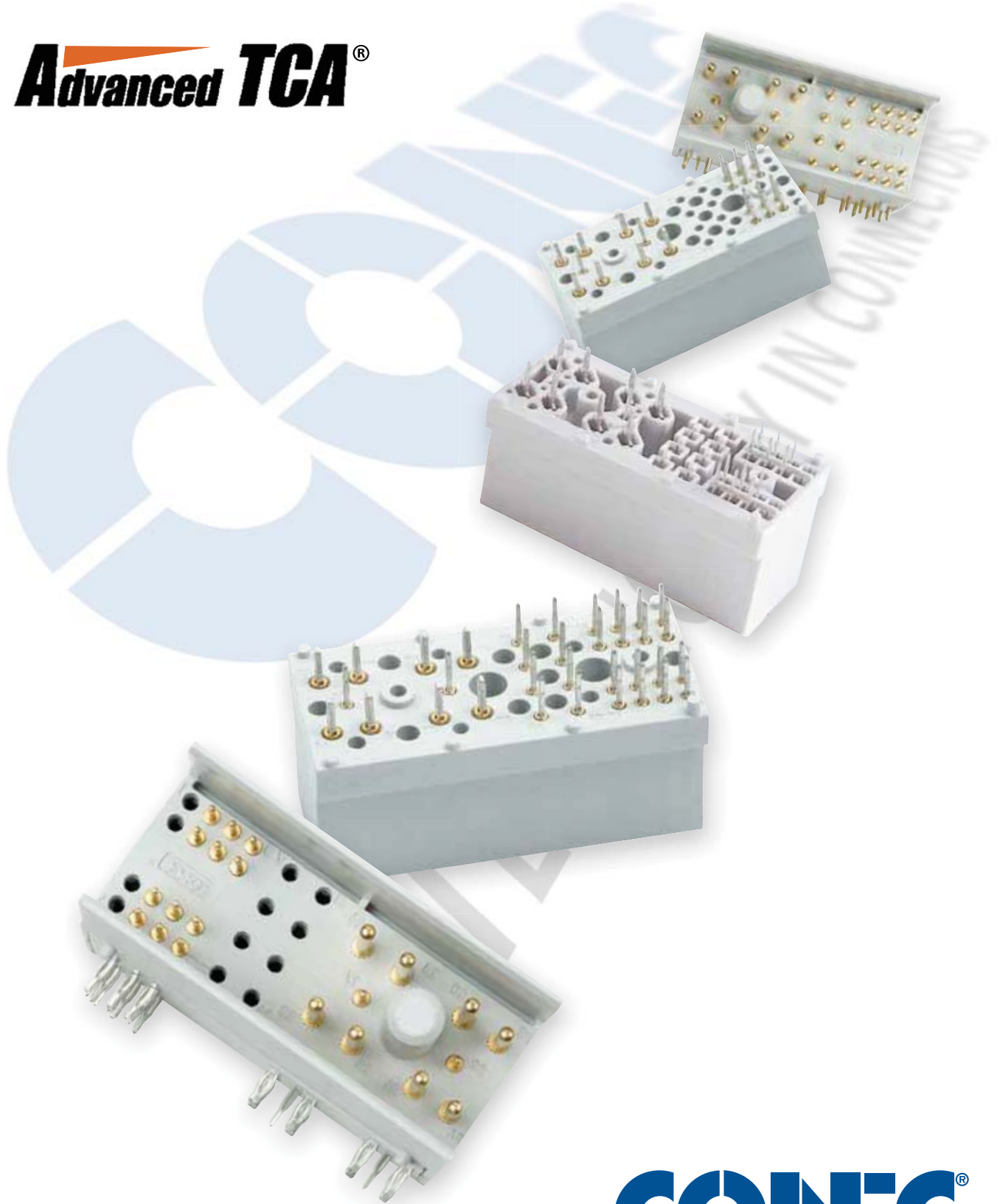

www.conec.com

CONEC[®]
TECHNOLOGY IN CONNECTORS™

SECTION 2

MICROTCA CONNECTORS

The MicroTCA system was developed beside the AdvancedTCA system to meet compact and cost effective requirements. This standard was also developed by the PICMG® group. Conec offers now the full range of interface connectors defined in the MicroTCA specification.

MicroTCA systems are modular constructed. The standard system configuration can consist of up to two Power Modules (PM's), two MicroTCA carrier hubs (MCH's) and up to 12 Advanced Mezzanine Cards (AMC's).

The MTCA.0 specification defines Combination D-SUB connectors type 7W2 and 9W4 as interfaces for the external power input to the power modules with direct voltage. These are populated with two power contacts, each with a current carrying capacity of 24 A per power pin for the 7W2 version (for use in power modules with -48/-60 V) and 49 A for the 9W4 version (module with +24 V) and two signal contacts.

Conec offers also special hoods in straight and angled version. These hoods are especially slim designed to fit into the MicroTCA connector footprint requirements.



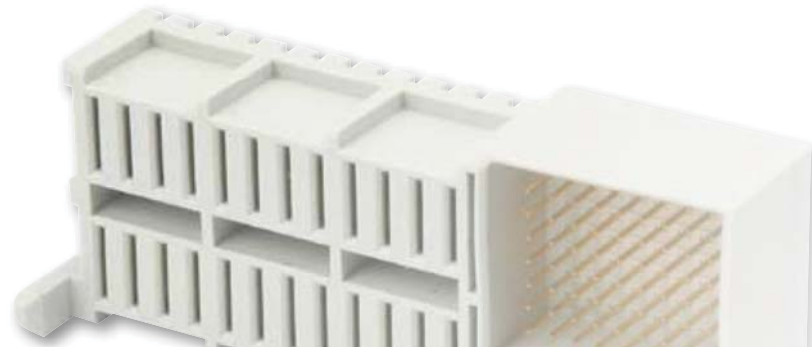

The energy will be supplied via power module output connectors from the PM into the MicroTCA backplane. This connector is a hybrid connector with 12 power contact pairs and 72 signal contacts in a 2.00 mm pitch. The angled version is applied to the PCB of the power module while the straight version is designed to be mounted on the system backplane. Alignment pins on the insulating body support the guide system of the module and allows a secured mating.

The current carrying capability is min. 9.3 A and a power module is able to supply the energy to twelve AMC Modules.

The interconnection from the MCH and the AMC modules to the backplane is made by the 170-pin high speed signal connector. This connector is a direct mating connector and allows data rates up to 12.5 Gbps. An additional internal conductive barrier supplies an additional shielding between the two signal layers. The connector is designed with „eye of the needle“ press fit contacts and will be installed into the systems backplane securely and without soldering.



TECHNICAL DATA

(AdvancedMC Connector)

Materials		
Housing	Liquid Crystal Polymer (LCP), UL 94-V0	
Contacts	Copper alloy	
Contact plating	Mating area gold over nickel	Termination area tin over nickel
Electrical characteristics		
Insulation resistance (IEC 60512)	General purpose contacts	0.4 A min.
	Ground contacts	0.3 A min.
	Power contacts	1.52 A min.
	Differential pair contacts	0.1 A min.
Contact resistance	25 mΩ	
Insulation resistance	100 MΩ	
Differential Impedance	100 Ω ± 10%	
Crosstalk	3 % (Multi aggressor condition)	
Differential skew	< 5 ps	
Mechanical Characteristics		
Mating cycles	200	
Mating force	100 N max.	
Withdrawal force	65 N max.	

Technical alterations are subjects to change without notice.

ADVANCEDMC CONNECTOR

Press fit technology – MicroTCA – for high speed signals

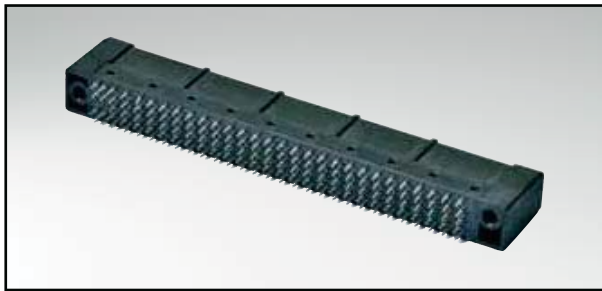

RoHS compliant

DESCRIPTION

- 170 "high speed" signal contacts
- Direct connector for AMC module
- Data transfer rates up to 12.5 Gbps
- Internal shielding
- Eye of the needle press fit
- Mating area gold plated, quality class 1

PRODUCT DRAWING

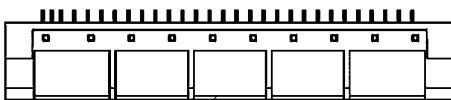
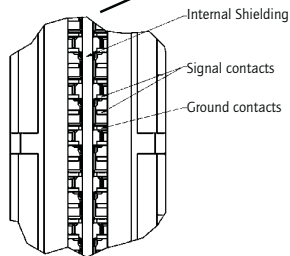
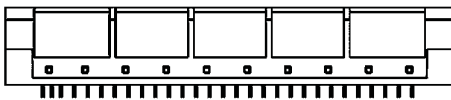

6,95 measured to bottom of card slot

PCB-hole pattern

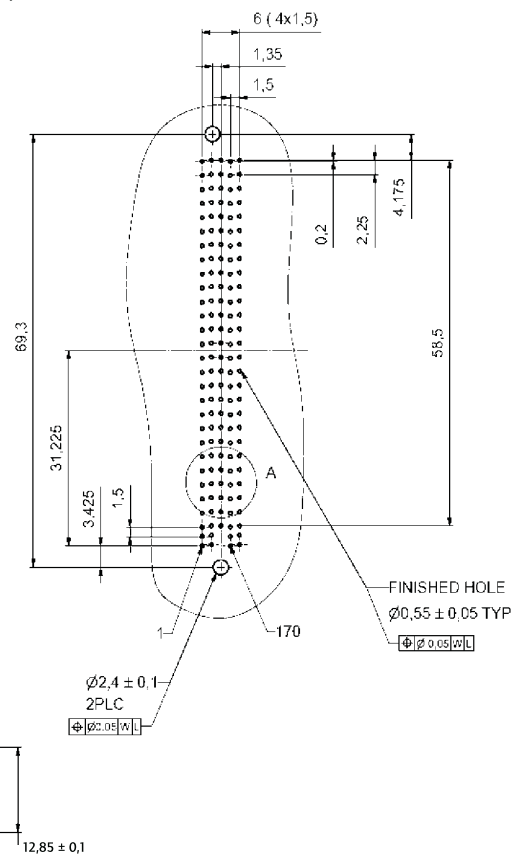

ORDER DATA

(Dim. = mm)

Number of positions	Part number
170	47-000001

TECHNICAL DATA

(Backplane and Power Modul Output Connector)

Materials		
Housing	Thermoplastic polyester, glass filled; UL94-V0	Color: grey
Power contacts	Copper alloy	Mating area gold over nickel Termination area tin plated
Signal contacts	Copper alloy	Termination gold over nickel Termination area tin plated
Electrical characteristics		
Insulation resistance (IEC 60512)	Power contacts and GND contacts	9.3 A per pin at max. 30°C temperature rise
	Signal- and Signal GND contacts	0.5 A at max. 30°C temperature rise
Contact material	Power contacts and GND contacts	11.625 A
	Signal- and Signal GND contacts	0.625 A
Contact resistance	Power contacts and GND contacts	5 mΩ
	Signal- and Signal GND contacts	25 mΩ
Insulation resistance	Power contacts	100 MΩ min.
	Signal contacts	100 MΩ min.
Temperature range	-55°C to +105°C	
Mechanical characteristics		
Mating cycles	200	
Mating force	145 N max.	
Withdrawal force	110 N max.	

Technical alterations are subjects to change without notice.

BACKPLANE CONNECTOR

Press fit technology – straight version

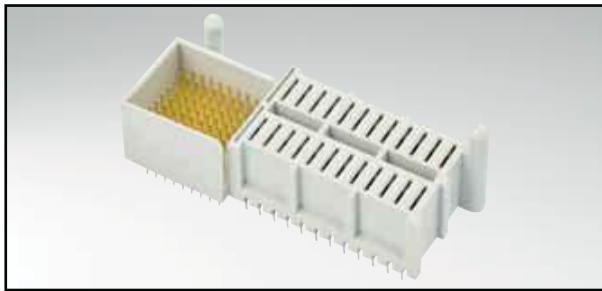

RoHS compliant

DESCRIPTION

- Connector according to MicroTCA specification
- Combination of signal- and power contacts
- Eye of the needle press fit
- Mating area gold plated, quality class 1

PRODUCT DRAWING

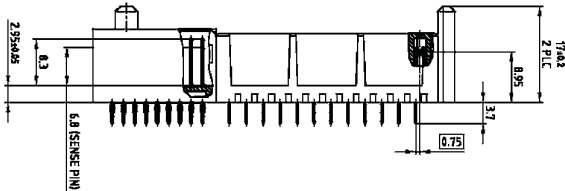

PCB-hole pattern

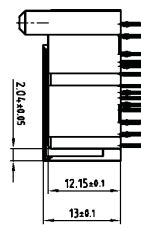
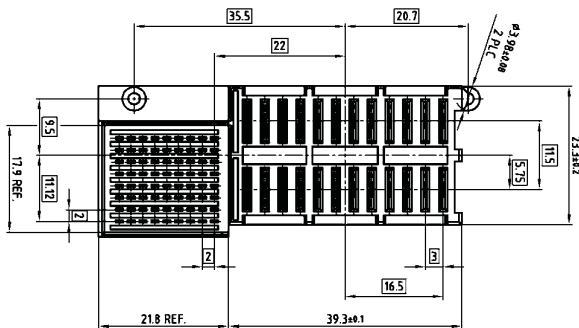
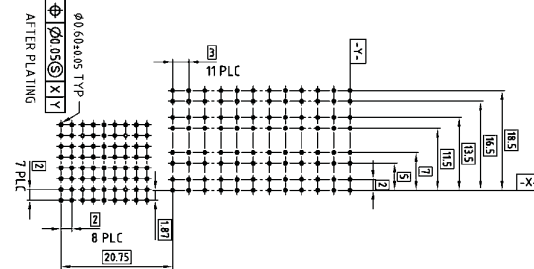

ORDER DATA

(Dim. = mm)

Number of positions	Contacts	Part number
96	72x signal / 24x power	47-100001

POWER MODULE OUTPUT CONNECTOR

Press fit technology – angled version

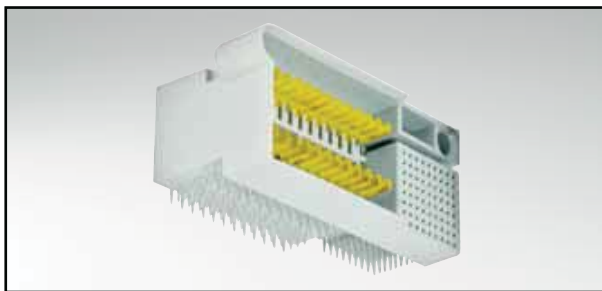

RoHS compliant

DESCRIPTION

- Connector according to MicroTCA specification
- Combination of signal- and power contacts
- Eye of the needle press fit
- Mating area gold plated, quality class 1

PRODUCT DRAWING

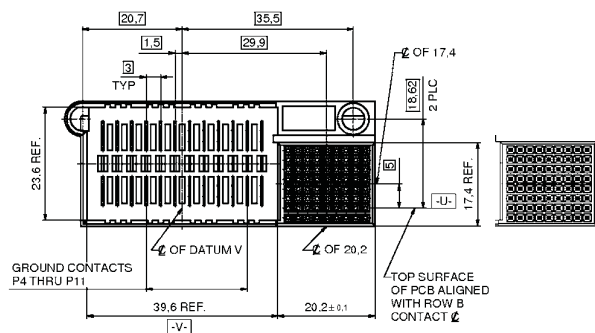

PCB-hole pattern

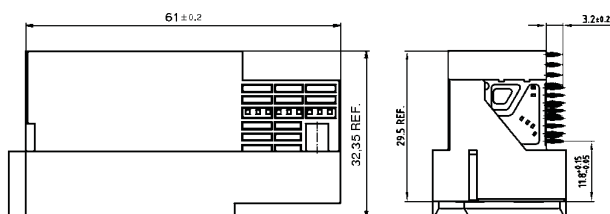
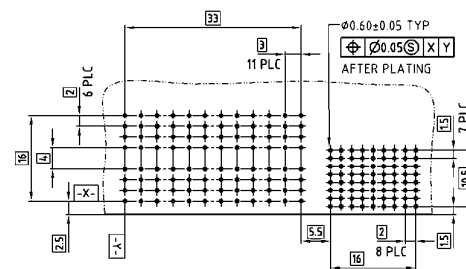

ORDER DATA

(Dim. = mm)

Number of positions	Contacts	Part number
96	72x signal / 24x power	47-100011

TECHNICAL DATA

Power Module Input Connector

Materials		
Insulator	PBT (UL 94-V0)	
Power Contacts	Copper alloy, Precision machined contacts	Mating side gold over nickel Soldering side tin over nickel
Signal contacts	Copper alloy, Precision machined contacts	Mating side gold over nickel Soldering side gold over nickel
Shell	Steel	Tin plated
Mounting bracket	Zink die-cast	Tin plated
4-40 UNC threaded insert	Copper alloy	Tin plated
Hex bolt with 4-40 UNC threaded insert and washers	Steel	Nickel plated
PCB clip for 1.6 mm PCB LP	Copper alloy	Tin plated
Electrical characteristics		
Current rating	Power contacts	24 A at max. 30°C temperature rise
	Signal contacts	7.5 A nominal
Clearance- and creepage distance	Power contacts	1.5 mm min.
	Signal contacts	0.4 mm min.
	Signal and power contacts	1.5 mm min.
	Power contacts and shell	1.5 mm min.
Insulation resistance	Signal contacts and shell	1.5 mm min.
	Power contact	5000 MΩ min.
	Signal contact	5000 MΩ min.
	Signal and power contacts	5000 MΩ min.
Dielectric with standing voltage	Power contacts and shell	5000 MΩ min.
	Signal contacts and shell	5000 MΩ min.
1000 V r.m.s.		
Mechanical characteristics		
Mating cycles	250	
Mating force	100 N max.	
Unmating force	65 N max.	

Technical alterations are subjects to change without notice.

POWER MODUL INPUT CONNECTORS

Plug connector – solder pin – angled – precision machined contacts – dual port style – through hole solder type

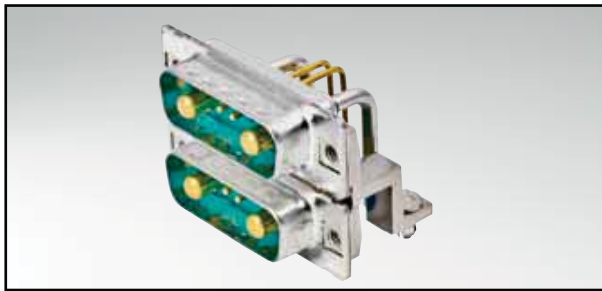

RoHS compliant

DESCRIPTION

- Standard version according to MTCA specification
- Design 7W2 for -48/-60 V Power modul
- 2 power contacts 24 A / 2 signal contacts per port
- Mounting styles:
 - Mounting bracket with PCB clip, 4-40 UNC threaded insert
 - Mounting bracket with PCB clip, 4-40 UNC hex bolt
- Note for 9W4 product please contact factory

PRODUCT DRAWING

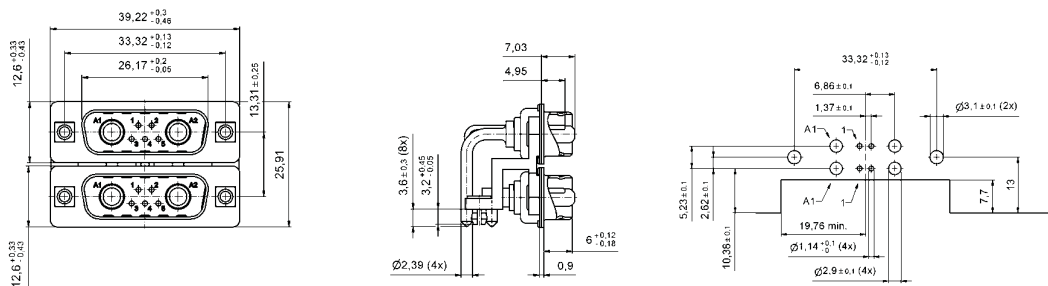

Mounting style:
Mounting bracket with PCB clip,
4-40 UNC threaded insert

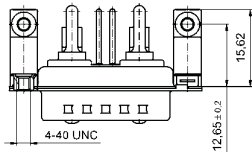

Mounting style:
Mounting bracket with PCB clip,
threaded insert and 4-40 UNC hex bolt

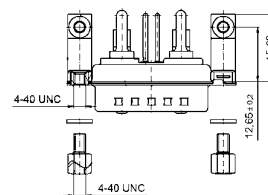

ORDER DATA

(Dim. = mm)

Version	PLUG CONNECTOR	
	Mounting style	Part number
7W2	Mounting bracket with PCB clip/Threaded insert and 4-40 UNC Hex bolt	13-000011
7W2	Mounting bracket with PCB clip/4-40 UNC Threaded insert	13-000021

PCB clip 3.1 mm ± 0.10 mm hole diameter and 1.6 mm circuit board thickness

POWER MODUL INPUT CONNECTORS

Plug connector – solder pin – angled – precision machined contacts – through hole solder type

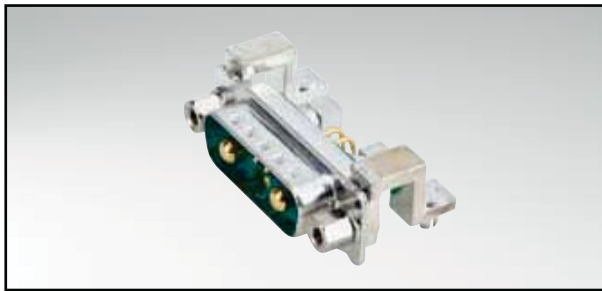

RoHS compliant

DESCRIPTION

- Design 7W2 for -48/-60 V power modul
- 2 power contacts 24 A / 2 signal contacts
- Single port version for MicroTCA PCB layout
- Mounting styles:
 - Mounting bracket with PCB clip, 4-40 UNC threaded insert
 - Mounting bracket with PCB clip, 4-40 UNC hex bolt
- Note for 9W4 product please contact factory

PRODUCT DRAWING

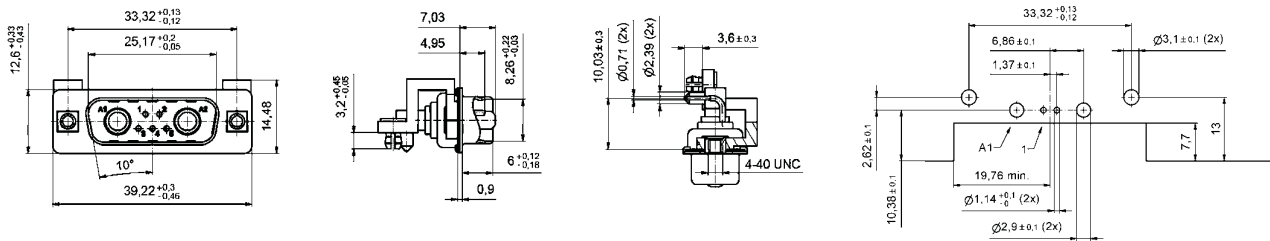

Mounting style:
Mounting bracket with PCB clip,
4-40 UNC threaded insert

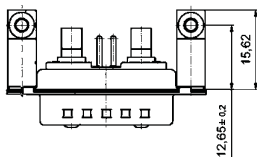

Mounting style:
Mounting bracket with PCB clip,
threaded insert and 4-40 UNC hex bolt

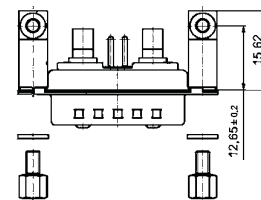

ORDER DATA

(Dim. = mm)

Version	PLUG CONNECTOR	
	Mounting style	Part number
7W2	Mounting bracket with PCB clip/Threaded insert and 4-40 UNC Hex bolt	13-000051
7W2	Mounting bracket with PCB clip/4-40 UNC Threaded insert	13-000061

PCB clip 3.1 mm ± 0.10 mm hole diameter and 1.6 mm circuit board thickness

POWER INPUT CONNECTOR

Socket connector – solder cup or crimp body

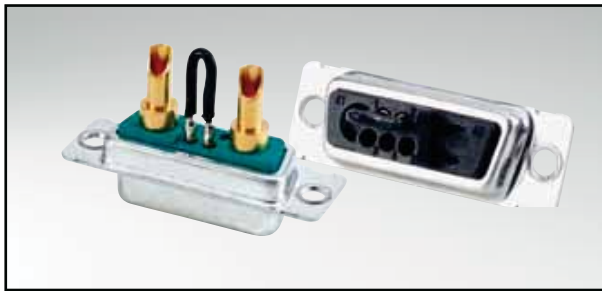

RoHS compliant

DESCRIPTION

- 7W2 MicroTCA Design: 2 power / 2 signal contacts
- Available with bridged and unbridged signal contacts
- Mounting style: with through-hole 3.0 mm
- Power contacts solder cup or crimp type wire size
- Note for 9W4 product please contact factory

PRODUCT DRAWING

Solder cup

AWG	X	Current Rating
10-12	3.5	max. 30 A
12-14	2.7	max. 20 A
16-20	1.8	max. 10 A

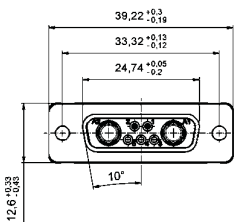

Crimp version

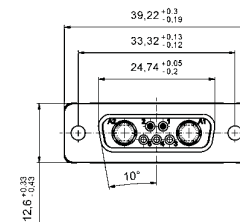

with signal contacts

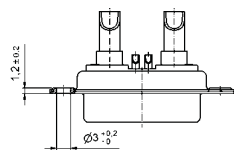

without signal contacts

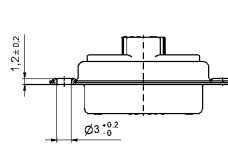

with bridged signal contacts

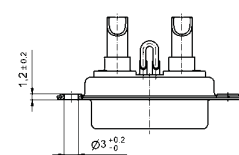

with bridged signal contacts

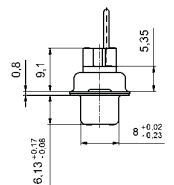
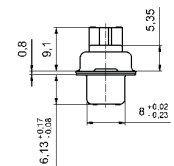
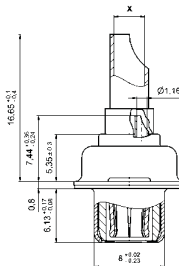
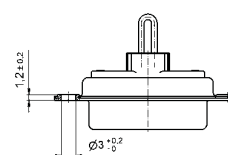

ORDER DATA

(Dim. = mm)

SOCKET CONNECTOR VERSION SOLDER CUP					
Version	Wire size	Current rating	Mounting style	Signal contacts	Part number
7W2	AWG 10 to 12	30 A	Through-hole 3.0 mm	unbridged	13-000131
7W2	AWG 12 to 14	20 A	Through-hole 3.0 mm	unbridged	13-000141
7W2	AWG 16 to 20	10 A	Through-hole 3.0 mm	unbridged	13-000151
7W2	AWG 10 to 12	30 A	Through-hole 3.0 mm	bridged	13-000161
7W2	AWG 12 to 14	20 A	Through-hole 3.0 mm	bridged	13-000171
7W2	AWG 16 to 20	10 A	Through-hole 3.0 mm	bridged	13-000181

SOCKET CONNECTOR CRIMP BODY					
Version	Design	Mounting style	Crimp signal contacts	Part number	
7W2	Crimp body	Through-hole 3.0 mm	without	13-000190	
7W2	Crimp body	Through-hole 3.0 mm	bridged	13-000201	

POWER INPUT CONTACTS

Socket contact – crimp body – precision machined

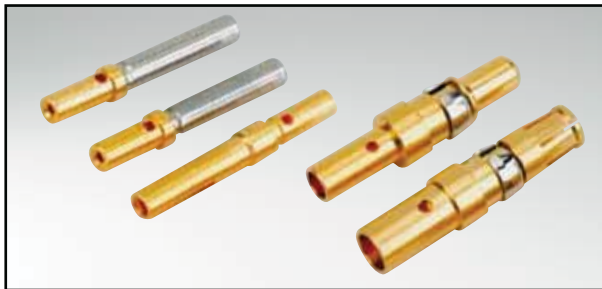

RoHS compliant

DESCRIPTION

- Precision machined contacts
- Quality class 1, standard
- Other quality classes on request

PRODUCT DRAWING

Signal Crimp contact (standard version)

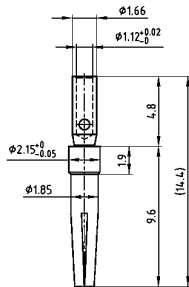

Signal Crimp contact (closed entry version)

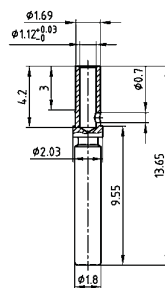

Power Crimp contact (standard version)

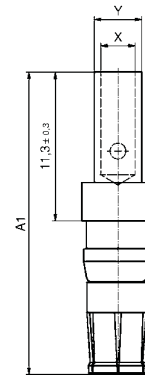

Power Crimp contact (short version)

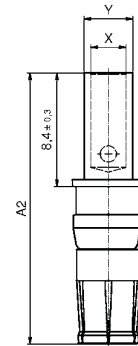

AWG	A ₁	A ₂	X	Y	Current rating
8 to 10		20.08	4.6	5.35	40 A
10 to 12	22.98	20.08	3.7	4.7	30 A
12 to 14	22.98	20.08	2.6	3.6	20 A
16 to 20	22.98	20.08	1.7	2.6	10 A

(Dim. = mm)

ORDER DATA

SOCKET CONNECTOR			
Contact	Wire cross section	Current rating	Part number
Signal crimp (standard version)	AWG 20 to 24	7,5 A	162 C 18709 X
Power crimp (standard version)	AWG 10 to 12 / A = 22.98	30 A	132 C 11039 X
Power crimp (standard version)	AWG 12 to 14 / A = 22.98	20 A	132 C 11029 X
Power crimp (standard version)	AWG 16 to 20 / A = 22.98	10 A	132 C 11019 X
Signal crimp (closed entry version)	AWG 20 to 24	7,5 A (Preferred type)	132 C 15019 X
Power crimp (for MicroTCA) (short version)	AWG 8 to 10 / A = 20.08	40 A	13-000321
Power crimp (for MicroTCA) (short version)	AWG 10 to 12 / A = 20.08	30 A	13-000311
Power crimp (for MicroTCA) (short version)	AWG 12 to 14 / A = 20.08	20 A	13-000301
Power crimp (for MicroTCA) (short version)	AWG 16 to 20 / A = 20.08	10 A	13-000291

CABLE HOOD AND CONNECTOR SET

Plastic hood with crimp connector body – straight cable entry



RoHS compliant

DESCRIPTION

- Compact 7W2 shell inclusive Crimp Socket connector
- Available with bridged signal contacts
- Short 4-40 UNC screws with Phillips or Allen key
- Material Housing: PBT GF; UL 94 V0, black
- Integrated strain relief
- Power contacts for wire size AWG 8 to AWG 20
- Hood can be used only with a special connector

PRODUCT DRAWING

Hood with short screw
(Socket connector included)

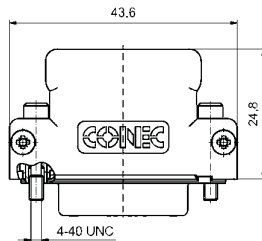
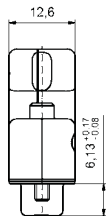
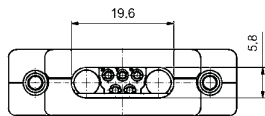
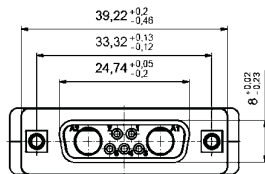

Hood with jack screw
(Socket connector included)

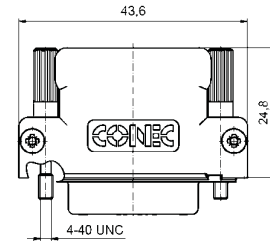
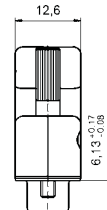
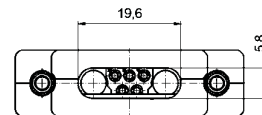
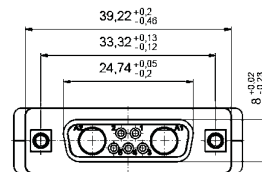

ORDER DATA

(Dim. = mm)

SOCKET CONNECTOR			
Version	Signal contacts	Screw design	Part number
Hood/Crimp Socket connector 7W2	without	Short/Allen key	13-000210
Hood/Crimp Socket connector 7W2	without	Short/Phillips head	13-000220
Hood/Crimp Socket connector 7W2	bridged	Short/Allen key	13-000231
Hood/Crimp Socket connector 7W2	bridged	Short/Phillips head	13-000241
Hood/Crimp Socket connector 7W2	without	Jack screw/Allen key	13-000370
Hood/Crimp Socket connector 7W2	without	Jack screw/Phillips head	13-000380
Hood/Crimp Socket connector 7W2	bridged	Jack screw/Allen key	13-000391
Hood/Crimp Socket connector 7W2	bridged	Jack screw/Phillips head	13-000401

CABLE HOOD

Metal design – side cable entry



RoHS compliant

DESCRIPTION

- Cable hood for 7W2 MicroTCA Standard Socket connector
- Suitable for other D-SUB Connectors
- Material: Zink die-cast
- Fastening with 4-40 UNC thread and jack screws
- Solide zink die-cast strain relief
- Plastic cable run integrated in shell

PRODUCT DRAWING

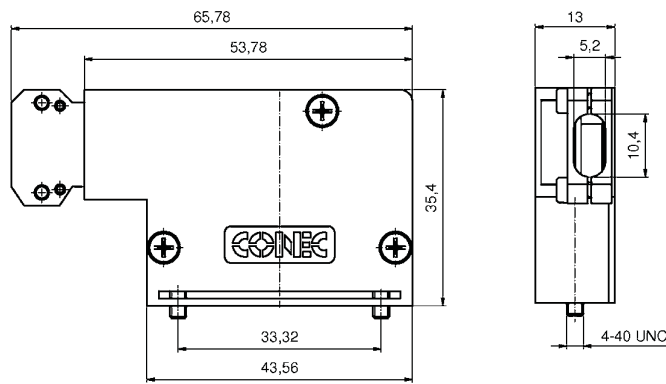

ORDER DATA

(Dim. = mm)

Version	Design	Part number
7W2	Metal hood	16-000010