



## SECTION 10

# IP67 FILTER D-SUB CONNECTORS

Many applications in harsh, industrial environments place additional demands on the interface.

The filtered, water resistant connector system developed by CONEC is well suited for applications that require increased EMC protection under ambient conditions where there is risk of dust and moisture.

The system includes D-Subminiature Connectors in standard and high-density designs.

This connector system designed to IEC 60529 with an IP67 rating. In order to ensure these requirements are met, special sealing measures have been taken for these connectors and their sealing frames. Special water resistant accessories and protective caps supplement the product line.



In2Connect UK Ltd

Tel: +44(0)1962 773004

Fax: +44(0)1962 600034

[Sales@in2connect.uk.com](mailto:Sales@in2connect.uk.com)

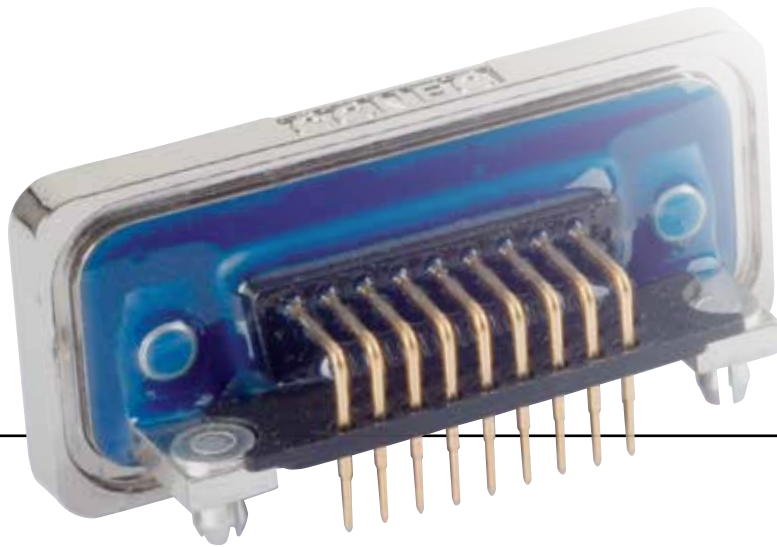

#### System details:

- Plastic or metal frame with O-ring for sealing
- Seal in the connector plug- water cannot penetrate into the housing
- Available for front side or rear side panel of the enclosure
- Connector without frame for cable housing
- Special threaded parts, 4-40 UNC and M 3
- Plastic materials comply with UL 94 V0
- Machined precision contacts for heavy duty usage
- Various gold plating options available
- All conventional contact termination types available
- Special accessories, e.g. water resistant hoods and sealing caps

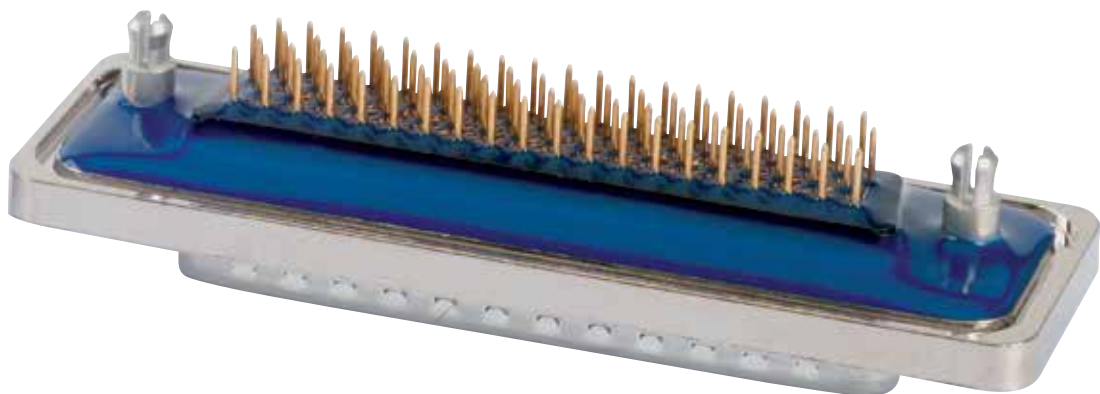

# PART NUMBER CREATOR

6 S T F O 9 P A M O 4 B 3 O X

### Product Line

- 4\* = Shell brass tin plated with plastic frame or without frame
- 6 = Shell brass tin plated with metal frame (Standard)  
(\*on request)

### Variations

- STF = D-Subminiatur Standard filtered
- HDF = D-Subminiatur High Density filtered

### No. of pos. for STF

- 09 = 09 pos.
- 15 = 15 pos.
- 25 = 25 pos.
- 37 = 37 pos.
- 50 = 50 pos.

### No. of pos. for HDF

- 15 = 15 pos.
- 26 = 26 pos.
- 44 = 44 pos.
- 62 = 62 pos.
- 78 = 78 pos.

### P

- = Plug connector (Standard)  
(Socket connector on request)

### Quality class / Plating code for contacts

- A = Quality class 3 = 50 mating cycles
- B = Quality class 2 = 200 mating cycles
- C = Quality class 1 = 500 mating cycles

### Termination

- M = Solder cup only for STF
- R = Solder pin, straight
- T = Solder pin, angled, .189" / 4.80 mm only for STF
- U = Solder pin, angled, .276" / 7.00 mm only for STF
- Z = Solder pin, angled, .465" / 11.80 mm only for STF
- Y = Solder pin, angled, .220" / 5.60 mm only for HDF

### Capacitance

- 01 = 180 pF ± 20% tolerance
- 03 = 370 pF ± 20% tolerance
- 04 = 830 pF ± 20% tolerance
- 05\* = 1300 pF ± 20% tolerance      \*not applicable for HDF

### Mounting style

- A1 = Riveted through hole for cable mount / Shell without sealing frame
- B2 = M3 threaded insert
- B3 = 4-40 UNC threaded insert
- B4 = Threaded lock for M3 front mounting
- B5 = Threaded lock for 4-40 UNC front mounting
- E1 = M3 threaded rear spacer with PCB clip, PCB .063" / 1.60 mm
- E2 = 4-40 UNC threaded rear spacer with PCB clip, PCB .063" / 1.60 mm
- S1 = Metal bracket, M3 threaded insert
- S2 = Metal bracket, 4-40 UNC threaded insert
- S3 = Metal bracket, M3 threaded insert and PCB clip
- S4 = Metal bracket, 4-40 UNC threaded insert and PCB clip
- R1 = Metal bracket, M3 threaded insert
- R2 = Metal bracket, 4-40 UNC threaded insert
- R3 = Metal bracket, M3 threaded insert and PCB clip
- R4 = Metal bracket, 4-40 UNC threaded insert and PCB clip

- OX = Standard

## PANEL CUT-OUT

### FRONT PANEL MOUNTING



### REAR PANEL MOUNTING



The hex bolts illustrated here (4-40 UNC or M3 threads) are included in the delivery complement of every connector with a sealing frame. The length of this spacer has been selected to accommodate a panel thickness of .063"/1.6 mm such that it does not extend beyond the plug-in height. Furthermore, the hex bolts outside threads are shorter than standard hex bolts. Material: stainless steel.

# IP67 C-FILTER D-SUB STANDARD

Plug connector – Solder cup – Precision machined contacts – For wire size AWG 26



RoHS compliant – CSA listed, File No.: LR 115000-1 – UL listed, File No.: E 202784

## DESCRIPTION

- Suitable for wire size AWG 26 (AWG 20 available on request)
- Mounting style:  
with 4-40 UNC or M3 threaded insert
- Quality class 3 (also available in quality class 1)
- Shell: brass tin plated
- Nickel plated die-cast frame  
(Black plastic frame on request)

## PRODUCT DRAWING

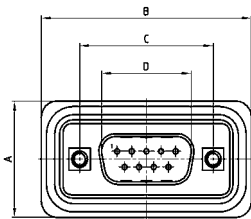

No. of pos.	A +0.30	B +0.30	C	D +0.25	E -0.30
09	21.10	39.40	25.00 <sup>+0.12</sup> <sub>-0.13</sub>	16.79	5.82
15	21.10	47.70	33.30 <sup>+0.15</sup> <sub>-0.10</sub>	25.12	5.82
25	21.10	61.40	47.04 <sup>+0.13</sup>	38.84	5.69
37	21.10	77.90	63.50 <sup>+0.13</sup>	55.30	5.69
50	23.90	75.50	61.10 <sup>+0.14</sup> <sub>-0.11</sub>	52.68	5.69

Mounting style: Threaded insert

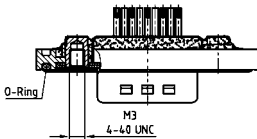

9-37 pos.

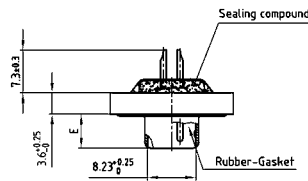

50 pos.

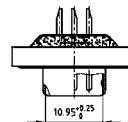

## ORDER DATA

Capacitance 180 pF

### PLUG CONNECTOR

No. of pos.	Mounting style M3	Part Number
09	Threaded insert	6STF09PAM01B20X
15	Threaded insert	6STF15PAM01B20X
25	Threaded insert	6STF25PAM01B20X
37	Threaded insert	6STF37PAM01B20X
50	Threaded insert	6STF50PAM01B20X

### PLUG CONNECTOR

No. of pos.	Mounting style 4-40 UNC	Part Number
09	Threaded insert	6STF09PAM01B30X
15	Threaded insert	6STF15PAM01B30X
25	Threaded insert	6STF25PAM01B30X
37	Threaded insert	6STF37PAM01B30X
50	Threaded insert	6STF50PAM01B30X

# IP67 C-FILTER D-SUB STANDARD

Plug connector – Solder cup – Precision machined contacts – For wire size AWG 26

## ORDER DATA

### Capacitance 370 pF

PLUG CONNECTOR			PLUG CONNECTOR		
No. of pos.	Mounting style M3	Part Number	No. of pos.	Mounting style 4-40 UNC	Part Number
09	Threaded insert	6STF09PAM03B20X	09	Threaded insert	6STF09PAM03B30X
15	Threaded insert	6STF15PAM03B20X	15	Threaded insert	6STF15PAM03B30X
25	Threaded insert	6STF25PAM03B20X	25	Threaded insert	6STF25PAM03B30X
37	Threaded insert	6STF37PAM03B20X	37	Threaded insert	6STF37PAM03B30X
50	Threaded insert	6STF50PAM03B20X	50	Threaded insert	6STF50PAM03B30X

### Capacitance 830 pF

PLUG CONNECTOR			PLUG CONNECTOR		
No. of pos.	Mounting style M3	Part Number	No. of pos.	Mounting style 4-40 UNC	Part Number
09	Threaded insert	6STF09PAM04B20X	09	Threaded insert	6STF09PAM04B30X
15	Threaded insert	6STF15PAM04B20X	15	Threaded insert	6STF15PAM04B30X
25	Threaded insert	6STF25PAM04B20X	25	Threaded insert	6STF25PAM04B30X
37	Threaded insert	6STF37PAM04B20X	37	Threaded insert	6STF37PAM04B30X
50	Threaded insert	6STF50PAM04B20X	50	Threaded insert	6STF50PAM04B30X

### Capacitance 1300 pF

PLUG CONNECTOR			PLUG CONNECTOR		
No. of pos.	Mounting style M3	Part Number	No. of pos.	Mounting style 4-40 UNC	Part Number
09	Threaded insert	6STF09PAM05B20X	09	Threaded insert	6STF09PAM05B30X
15	Threaded insert	6STF15PAM05B20X	15	Threaded insert	6STF15PAM05B30X
25	Threaded insert	6STF25PAM05B20X	25	Threaded insert	6STF25PAM05B30X
37	Threaded insert	6STF37PAM05B20X	37	Threaded insert	6STF37PAM05B30X
50	Threaded insert	6STF50PAM05B20X	50	Threaded insert	6STF50PAM05B30X

# IP67 C-FILTER D-SUB STANDARD

Plug connector – Solder pin – Straight – Precision machined contacts



RoHS compliant – CSA listed, File No.: LR 115000-1 – UL listed, File No.: E 202784

## DESCRIPTION

- Mounting styles:
  - with 4-40 UNC or M3 threaded insert
  - with 4-40 UNC or M3 threaded rear spacer with PCB clip
- Quality class 3 (also available in quality class 1)
- Shell: brass tin plated
- Nickel plated die-cast frame  
(Black plastic frame on request)

## PRODUCT DRAWING

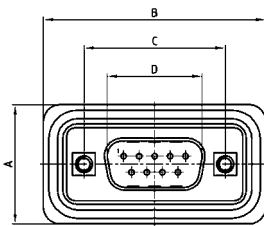

No. of pos.	A +0.30	B +0.30	C	D +0.25	E -0.30
09	21.10	39.40	25.00 <sup>+0.12</sup> <sub>-0.13</sub>	16.79	5.82
15	21.10	47.70	33.30 <sup>+0.15</sup> <sub>-0.10</sub>	25.12	5.82
25	21.10	61.40	47.04 <sup>+0.13</sup>	38.84	5.69
37	21.10	77.90	63.50 <sup>+0.13</sup>	55.30	5.69
50	23.90	75.50	61.10 <sup>+0.14</sup> <sub>-0.11</sub>	52.68	5.69

PCB-Layout: Kat1kFVA / Kat1kFUA

Mounting style: Threaded insert

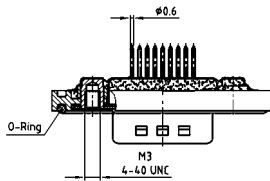

9-37 pos.

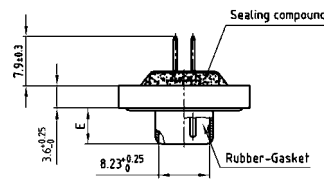

Mounting style: Threaded rear spacer with PCB clip

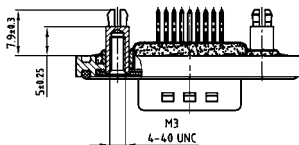

50 pos.

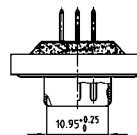

## ORDER DATA

Capacitance 180 pF

PLUG CONNECTOR			PLUG CONNECTOR		
No. of pos.	Mounting style	Part Number	No. of pos.	Mounting style	Part Number
09	M3 Threaded insert	6STF09PAR01 B20X	09	M3 Threaded rear spacer PCB clip	6STF09PAR01 E10X
15	M3 Threaded insert	6STF15PAR01 B20X	15	M3 Threaded rear spacer PCB clip	6STF15PAR01 E10X
25	M3 Threaded insert	6STF25PAR01 B20X	25	M3 Threaded rear spacer PCB clip	6STF25PAR01 E10X
37	M3 Threaded insert	6STF37PAR01 B20X	37	M3 Threaded rear spacer PCB clip	6STF37PAR01 E10X
50	M3 Threaded insert	6STF50PAR01 B20X	50	M3 Threaded rear spacer PCB clip	6STF50PAR01 E10X
09	4-40 UNC Threaded insert	6STF09PAR01 B30X	09	4-40 UNC Threaded rear spacer PCB clip	6STF09PAR01 E20X
15	4-40 UNC Threaded insert	6STF15PAR01 B30X	15	4-40 UNC Threaded rear spacer PCB clip	6STF15PAR01 E20X
25	4-40 UNC Threaded insert	6STF25PAR01 B30X	25	4-40 UNC Threaded rear spacer PCB clip	6STF25PAR01 E20X
37	4-40 UNC Threaded insert	6STF37PAR01 B30X	37	4-40 UNC Threaded rear spacer PCB clip	6STF37PAR01 E20X
50	4-40 UNC Threaded insert	6STF50PAR01 B30X	50	4-40 UNC Threaded rear spacer PCB clip	6STF50PAR01 E20X

PCB clip .122" / 3.1 ± .004" / 0.10 mm hole diameter and .063" / 1.6 mm circuit board thickness

# IP67 C-FILTER D-SUB STANDARD

Plug connector – Solder pin – Straight – Precision machined contacts

## ORDER DATA

### Capacitance 370 pF

PLUG CONNECTOR			PLUG CONNECTOR		
No. of pos.	Mounting style	Part Number	No. of pos.	Mounting style	Part Number
09	M3 Threaded insert	6STF09PAR03B20X	09	M3 Threaded rear spacer PCB clip	6STF09PAR03E10X
15	M3 Threaded insert	6STF15PAR03B20X	15	M3 Threaded rear spacer PCB clip	6STF15PAR03E10X
25	M3 Threaded insert	6STF25PAR03B20X	25	M3 Threaded rear spacer PCB clip	6STF25PAR03E10X
37	M3 Threaded insert	6STF37PAR03B20X	37	M3 Threaded rear spacer PCB clip	6STF37PAR03E10X
50	M3 Threaded insert	6STF50PAR03B20X	50	M3 Threaded rear spacer PCB clip	6STF50PAR03E10X
09	4-40 UNC Threaded insert	6STF09PAR03B30X	09	4-40 UNC Threaded rear spacer PCB clip	6STF09PAR03E20X
15	4-40 UNC Threaded insert	6STF15PAR03B30X	15	4-40 UNC Threaded rear spacer PCB clip	6STF15PAR03E20X
25	4-40 UNC Threaded insert	6STF25PAR03B30X	25	4-40 UNC Threaded rear spacer PCB clip	6STF25PAR03E20X
37	4-40 UNC Threaded insert	6STF37PAR03B30X	37	4-40 UNC Threaded rear spacer PCB clip	6STF37PAR03E20X
50	4-40 UNC Threaded insert	6STF50PAR03B30X	50	4-40 UNC Threaded rear spacer PCB clip	6STF50PAR03E20X

### Capacitance 830 pF

PLUG CONNECTOR			PLUG CONNECTOR		
No. of pos.	Mounting style	Part Number	No. of pos.	Mounting style	Part Number
09	M3 Threaded insert	6STF09PAR04B20X	09	M3 Threaded rear spacer PCB clip	6STF09PAR04E10X
15	M3 Threaded insert	6STF15PAR04B20X	15	M3 Threaded rear spacer PCB clip	6STF15PAR04E10X
25	M3 Threaded insert	6STF25PAR04B20X	25	M3 Threaded rear spacer PCB clip	6STF25PAR04E10X
37	M3 Threaded insert	6STF37PAR04B20X	37	M3 Threaded rear spacer PCB clip	6STF37PAR04E10X
50	M3 Threaded insert	6STF50PAR04B20X	50	M3 Threaded rear spacer PCB clip	6STF50PAR04E10X
09	4-40 UNC Threaded insert	6STF09PAR04B30X	09	4-40 UNC Threaded rear spacer PCB clip	6STF09PAR04E20X
15	4-40 UNC Threaded insert	6STF15PAR04B30X	15	4-40 UNC Threaded rear spacer PCB clip	6STF15PAR04E20X
25	4-40 UNC Threaded insert	6STF25PAR04B30X	25	4-40 UNC Threaded rear spacer PCB clip	6STF25PAR04E20X
37	4-40 UNC Threaded insert	6STF37PAR04B30X	37	4-40 UNC Threaded rear spacer PCB clip	6STF37PAR04E20X
50	4-40 UNC Threaded insert	6STF50PAR04B30X	50	4-40 UNC Threaded rear spacer PCB clip	6STF50PAR04E20X

### Capacitance 1300 pF

PLUG CONNECTOR			PLUG CONNECTOR		
No. of pos.	Mounting style	Part Number	No. of pos.	Mounting style	Part Number
09	M3 Threaded insert	6STF09PAR05B20X	09	M3 Threaded rear spacer PCB clip	6STF09PAR05E10X
15	M3 Threaded insert	6STF15PAR05B20X	15	M3 Threaded rear spacer PCB clip	6STF15PAR05E10X
25	M3 Threaded insert	6STF25PAR05B20X	25	M3 Threaded rear spacer PCB clip	6STF25PAR05E10X
37	M3 Threaded insert	6STF37PAR05B20X	37	M3 Threaded rear spacer PCB clip	6STF37PAR05E10X
50	M3 Threaded insert	6STF50PAR05B20X	50	M3 Threaded rear spacer PCB clip	6STF50PAR05E10X
09	4-40 UNC Threaded insert	6STF09PAR05B30X	09	4-40 UNC Threaded rear spacer PCB clip	6STF09PAR05E20X
15	4-40 UNC Threaded insert	6STF15PAR05B30X	15	4-40 UNC Threaded rear spacer PCB clip	6STF15PAR05E20X
25	4-40 UNC Threaded insert	6STF25PAR05B30X	25	4-40 UNC Threaded rear spacer PCB clip	6STF25PAR05E20X
37	4-40 UNC Threaded insert	6STF37PAR05B30X	37	4-40 UNC Threaded rear spacer PCB clip	6STF37PAR05E20X
50	4-40 UNC Threaded insert	6STF50PAR05B30X	50	4-40 UNC Threaded rear spacer PCB clip	6STF50PAR05E20X



# IP67 C-FILTER D-SUB STANDARD

Plug connector – Solder pin – Angled – .189" / 4.8 mm –  
Precision machined contacts – Metal bracket

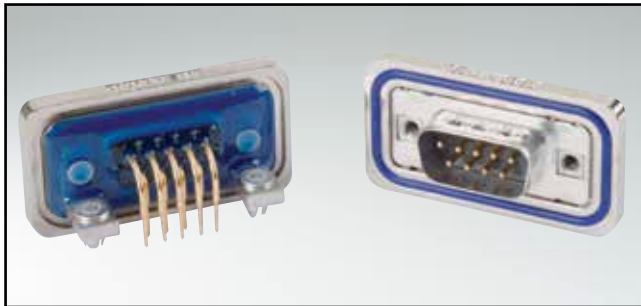

RoHS compliant – CSA listed, File No.: LR 115000-1 – UL listed, File No.: E 202784

## DESCRIPTION

- Mounting styles:
  - with 4-40 UNC or M3 threaded insert
  - with mounting bracket, PCB clip and 4-40 UNC or M3 threaded insert
- Quality class 3 (also available in quality class 1)
- Shell: brass tin plated
- Nickel plated die-cast frame (Black plastic frame on request)

## PRODUCT DRAWING

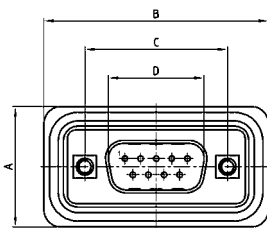

No. of pos.	A +0.30	B +0.30	C	D +0.25	E -0.30
09	21.10	39.40	25.00 <sup>+0.12</sup> <sub>-0.13</sub>	16.79	5.82
15	21.10	47.70	33.30 <sup>+0.15</sup> <sub>-0.10</sub>	25.12	5.82
25	21.10	61.40	47.04 <sup>+0.13</sup>	38.84	5.69
37	21.10	77.90	63.50 <sup>+0.13</sup>	55.30	5.69

PCB-Layout: Kat1kGSA

Mounting style: Threaded insert

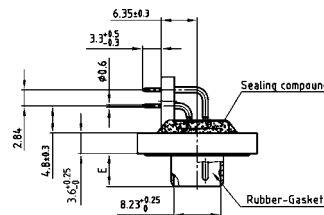

Mounting style: PCB clip, threaded insert

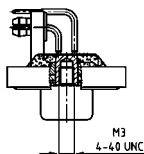

## ORDER DATA

Capacitance 180 pF

PLUG CONNECTOR			PLUG CONNECTOR		
No. of pos.	Mounting style	Part Number	No. of pos.	Mounting style	Part Number
09	M3 Threaded insert	6STF09PAT01S10X	09	PCB clip / M3 Threaded insert	6STF09PAT01S30X
15	M3 Threaded insert	6STF15PAT01S10X	15	PCB clip / M3 Threaded insert	6STF15PAT01S30X
25	M3 Threaded insert	6STF25PAT01S10X	25	PCB clip / M3 Threaded insert	6STF25PAT01S30X
37	M3 Threaded insert	6STF37PAT01S10X	37	PCB clip / M3 Threaded insert	6STF37PAT01S30X
09	4-40 UNC Threaded insert	6STF09PAT01S20X	09	PCB clip / 4-40 UNC Threaded insert	6STF09PAT01S40X
15	4-40 UNC Threaded insert	6STF15PAT01S20X	15	PCB clip / 4-40 UNC Threaded insert	6STF15PAT01S40X
25	4-40 UNC Threaded insert	6STF25PAT01S20X	25	PCB clip / 4-40 UNC Threaded insert	6STF25PAT01S40X
37	4-40 UNC Threaded insert	6STF37PAT01S20X	37	PCB clip / 4-40 UNC Threaded insert	6STF37PAT01S40X

PCB clip .122" / 3.1 ± .004" / 0.10 mm hole diameter and .063" / 1.6 mm circuit board thickness

# IP67 C-FILTER D-SUB STANDARD

Plug connector – Solder pin – Angled – .189" / 4.8 mm –

Precision machined contacts – Metal bracket

## ORDER DATA

### Capacitance 370 pF

PLUG CONNECTOR			PLUG CONNECTOR		
No. of pos.	Mounting style	Part Number	No. of pos.	Mounting style	Part Number
09	M3 Threaded insert	6STF09PAT03S10X	09	PCB clip / M3 Threaded insert	6STF09PAT03S30X
15	M3 Threaded insert	6STF15PAT03S10X	15	PCB clip / M3 Threaded insert	6STF15PAT03S30X
25	M3 Threaded insert	6STF25PAT03S10X	25	PCB clip / M3 Threaded insert	6STF25PAT03S30X
37	M3 Threaded insert	6STF37PAT03S10X	37	PCB clip / M3 Threaded insert	6STF37PAT03S30X
09	4-40 UNC Threaded insert	6STF09PAT03S20X	09	PCB clip / 4-40 UNC Threaded insert	6STF09PAT03S40X
15	4-40 UNC Threaded insert	6STF15PAT03S20X	15	PCB clip / 4-40 UNC Threaded insert	6STF15PAT03S40X
25	4-40 UNC Threaded insert	6STF25PAT03S20X	25	PCB clip / 4-40 UNC Threaded insert	6STF25PAT03S40X
37	4-40 UNC Threaded insert	6STF37PAT03S20X	37	PCB clip / 4-40 UNC Threaded insert	6STF37PAT03S40X

### Capacitance 830 pF

PLUG CONNECTOR			PLUG CONNECTOR		
No. of pos.	Mounting style	Part Number	No. of pos.	Mounting style	Part Number
09	M3 Threaded insert	6STF09PAT04S10X	09	PCB clip / M3 Threaded insert	6STF09PAT04S30X
15	M3 Threaded insert	6STF15PAT04S10X	15	PCB clip / M3 Threaded insert	6STF15PAT04S30X
25	M3 Threaded insert	6STF25PAT04S10X	25	PCB clip / M3 Threaded insert	6STF25PAT04S30X
37	M3 Threaded insert	6STF37PAT04S10X	37	PCB clip / M3 Threaded insert	6STF37PAT04S30X
09	4-40 UNC Threaded insert	6STF09PAT04S20X	09	PCB clip / 4-40 UNC Threaded insert	6STF09PAT04S40X
15	4-40 UNC Threaded insert	6STF15PAT04S20X	15	PCB clip / 4-40 UNC Threaded insert	6STF15PAT04S40X
25	4-40 UNC Threaded insert	6STF25PAT04S20X	25	PCB clip / 4-40 UNC Threaded insert	6STF25PAT04S40X
37	4-40 UNC Threaded insert	6STF37PAT04S20X	37	PCB clip / 4-40 UNC Threaded insert	6STF37PAT04S40X

### Capacitance 1300 pF

PLUG CONNECTOR			PLUG CONNECTOR		
No. of pos.	Mounting style	Part Number	No. of pos.	Mounting style	Part Number
09	M3 Threaded insert	6STF09PAT05S10X	09	PCB clip / M3 Threaded insert	6STF09PAT05S30X
15	M3 Threaded insert	6STF15PAT05S10X	15	PCB clip / M3 Threaded insert	6STF15PAT05S30X
25	M3 Threaded insert	6STF25PAT05S10X	25	PCB clip / M3 Threaded insert	6STF25PAT05S30X
37	M3 Threaded insert	6STF37PAT05S10X	37	PCB clip / M3 Threaded insert	6STF37PAT05S30X
09	4-40 UNC Threaded insert	6STF09PAT05S20X	09	PCB clip / 4-40 UNC Threaded insert	6STF09PAT05S40X
15	4-40 UNC Threaded insert	6STF15PAT05S20X	15	PCB clip / 4-40 UNC Threaded insert	6STF15PAT05S40X
25	4-40 UNC Threaded insert	6STF25PAT05S20X	25	PCB clip / 4-40 UNC Threaded insert	6STF25PAT05S40X
37	4-40 UNC Threaded insert	6STF37PAT05S20X	37	PCB clip / 4-40 UNC Threaded insert	6STF37PAT05S40X

PCB clip .122" / 3.1 ± .004" / 0.10 mm hole diameter and .063" / 1.6 mm circuit board thickness

# IP67 C-FILTER D-SUB STANDARD

Plug connector – Solder pin – Angled – .276" / 7.0 mm –  
Precision machined contacts – Metal bracket

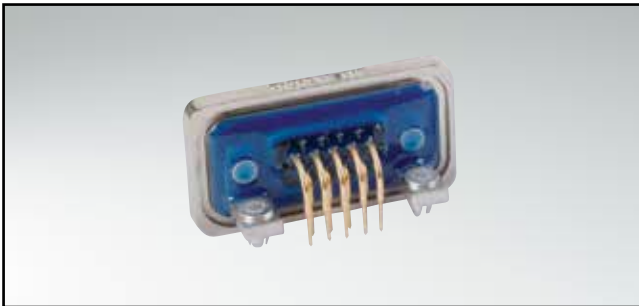

RoHS compliant – CSA listed, File No.: LR 115000-1 – UL listed, File No.: E 202784

## DESCRIPTION

- Mounting styles:
  - with 4-40 UNC or M3 threaded insert
  - with mounting bracket, PCB clip and 4-40 UNC or M3 threaded insert
- Quality class 3 (also available in quality class 1)
- Shell: brass tin plated
- Nickel plated die-cast frame  
(Black plastic frame on request)

## PRODUCT DRAWING

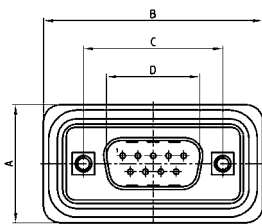

No. of pos.	A +0.30	B +0.30	C	D +0.25	E -0.30
09	21.10	39.40	25.00 <sup>+0.12</sup> <sub>-0.13</sub>	16.79	5.82
15	21.10	47.70	33.30 <sup>+0.15</sup> <sub>-0.10</sub>	25.12	5.82
25	21.10	61.40	47.04 <sup>+0.13</sup>	38.84	5.69
37	21.10	77.90	63.50 <sup>+0.13</sup>	55.30	5.69
50	23.90	75.50	61.10 <sup>+0.14</sup> <sub>-0.11</sub>	52.68	5.69

PCB-Layout: Kat1kGTA

Mounting style: Threaded insert

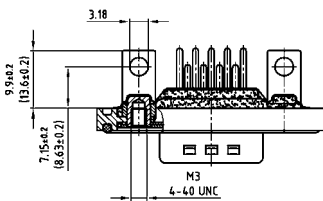

Mounting style: PCB clip, threaded insert

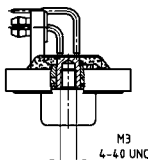

9-37 pos.

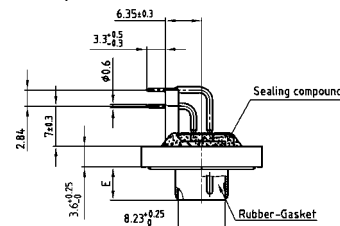

50 pos.

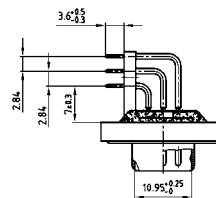

## ORDER DATA

### Capacitance 180 pF

PLUG CONNECTOR			PLUG CONNECTOR		
No. of pos.	Mounting style	Part Number	No. of pos.	Mounting style	Part Number
09	M3 Threaded insert	6STF09PAU01R10X	09	PCB clip / M3 Threaded insert	6STF09PAU01R30X
15	M3 Threaded insert	6STF15PAU01R10X	15	PCB clip / M3 Threaded insert	6STF15PAU01R30X
25	M3 Threaded insert	6STF25PAU01R10X	25	PCB clip / M3 Threaded insert	6STF25PAU01R30X
37	M3 Threaded insert	6STF37PAU01R10X	37	PCB clip / M3 Threaded insert	6STF37PAU01R30X
50	M3 Threaded insert	6STF50PAU01R10X	50	PCB clip / M3 Threaded insert	6STF50PAU01R30X
09	4-40 UNC Threaded insert	6STF09PAU01R20X	09	PCB clip / 4-40 UNC Threaded insert	6STF09PAU01R40X
15	4-40 UNC Threaded insert	6STF15PAU01R20X	15	PCB clip / 4-40 UNC Threaded insert	6STF15PAU01R40X
25	4-40 UNC Threaded insert	6STF25PAU01R20X	25	PCB clip / 4-40 UNC Threaded insert	6STF25PAU01R40X
37	4-40 UNC Threaded insert	6STF37PAU01R20X	37	PCB clip / 4-40 UNC Threaded insert	6STF37PAU01R40X
50	4-40 UNC Threaded insert	6STF50PAU01R20X	50	PCB clip / 4-40 UNC Threaded insert	6STF50PAU01R40X

PCB clip .122" / 3.1 ± .004" / 0.10 mm hole diameter and .063" / 1.6 mm circuit board thickness

# IP67 C-FILTER D-SUB STANDARD

Plug connector – Solder pin – Angled – .276" / 7.0 mm –

Precision machined contacts – Metal bracket

## ORDER DATA

### Capacitance 370 pF

PLUG CONNECTOR			PLUG CONNECTOR		
No. of pos.	Mounting style	Part Number	No. of pos.	Mounting style	Part Number
09	M3 Threaded insert	6STF09PAU03R10X	09	PCB clip / M3 Threaded insert	6STF09PAU03R30X
15	M3 Threaded insert	6STF15PAU03R10X	15	PCB clip / M3 Threaded insert	6STF15PAU03R30X
25	M3 Threaded insert	6STF25PAU03R10X	25	PCB clip / M3 Threaded insert	6STF25PAU03R30X
37	M3 Threaded insert	6STF37PAU03R10X	37	PCB clip / M3 Threaded insert	6STF37PAU03R30X
50	M3 Threaded insert	6STF50PAU03R10X	50	PCB clip / M3 Threaded insert	6STF50PAU03R30X
09	4-40 UNC Threaded insert	6STF09PAU03R20X	09	PCB clip / 4-40 UNC Threaded insert	6STF09PAU03R40X
15	4-40 UNC Threaded insert	6STF15PAU03R20X	15	PCB clip / 4-40 UNC Threaded insert	6STF15PAU03R40X
25	4-40 UNC Threaded insert	6STF25PAU03R20X	25	PCB clip / 4-40 UNC Threaded insert	6STF25PAU03R40X
37	4-40 UNC Threaded insert	6STF37PAU03R20X	37	PCB clip / 4-40 UNC Threaded insert	6STF37PAU03R40X
50	4-40 UNC Threaded insert	6STF50PAU03R20X	50	PCB clip / 4-40 UNC Threaded insert	6STF50PAU03R40X

### Capacitance 830 pF

PLUG CONNECTOR			PLUG CONNECTOR		
No. of pos.	Mounting style	Part Number	No. of pos.	Mounting style	Part Number
09	M3 Threaded insert	6STF09PAU04R10X	09	PCB clip / M3 Threaded insert	6STF09PAU04R30X
15	M3 Threaded insert	6STF15PAU04R10X	15	PCB clip / M3 Threaded insert	6STF15PAU04R30X
25	M3 Threaded insert	6STF25PAU04R10X	25	PCB clip / M3 Threaded insert	6STF25PAU04R30X
37	M3 Threaded insert	6STF37PAU04R10X	37	PCB clip / M3 Threaded insert	6STF37PAU04R30X
50	M3 Threaded insert	6STF50PAU04R10X	50	PCB clip / M3 Threaded insert	6STF50PAU04R30X
09	4-40 UNC Threaded insert	6STF09PAU04R20X	09	PCB clip / 4-40 UNC Threaded insert	6STF09PAU04R40X
15	4-40 UNC Threaded insert	6STF15PAU04R20X	15	PCB clip / 4-40 UNC Threaded insert	6STF15PAU04R40X
25	4-40 UNC Threaded insert	6STF25PAU04R20X	25	PCB clip / 4-40 UNC Threaded insert	6STF25PAU04R40X
37	4-40 UNC Threaded insert	6STF37PAU04R20X	37	PCB clip / 4-40 UNC Threaded insert	6STF37PAU04R40X
50	4-40 UNC Threaded insert	6STF50PAU04R20X	50	PCB clip / 4-40 UNC Threaded insert	6STF50PAU04R40X

### Capacitance 1300 pF

PLUG CONNECTOR			PLUG CONNECTOR		
No. of pos.	Mounting style	Part Number	No. of pos.	Mounting style	Part Number
09	M3 Threaded insert	6STF09PAU05R10X	09	PCB clip / M3 Threaded insert	6STF09PAU05R30X
15	M3 Threaded insert	6STF15PAU05R10X	15	PCB clip / M3 Threaded insert	6STF15PAU05R30X
25	M3 Threaded insert	6STF25PAU05R10X	25	PCB clip / M3 Threaded insert	6STF25PAU05R30X
37	M3 Threaded insert	6STF37PAU05R10X	37	PCB clip / M3 Threaded insert	6STF37PAU05R30X
50	M3 Threaded insert	6STF50PAU05R10X	50	PCB clip / M3 Threaded insert	6STF50PAU05R30X
09	4-40 UNC Threaded insert	6STF09PAU05R20X	09	PCB clip / 4-40 UNC Threaded insert	6STF09PAU05R40X
15	4-40 UNC Threaded insert	6STF15PAU05R20X	15	PCB clip / 4-40 UNC Threaded insert	6STF15PAU05R40X
25	4-40 UNC Threaded insert	6STF25PAU05R20X	25	PCB clip / 4-40 UNC Threaded insert	6STF25PAU05R40X
37	4-40 UNC Threaded insert	6STF37PAU05R20X	37	PCB clip / 4-40 UNC Threaded insert	6STF37PAU05R40X
50	4-40 UNC Threaded insert	6STF50PAU05R20X	50	PCB clip / 4-40 UNC Threaded insert	6STF50PAU05R40X

PCB clip .122" / 3.1 ± .004" / 0.10 mm hole diameter and .063" / 1.6 mm circuit board thickness

# IP67 C-FILTER D-SUB STANDARD

Plug connector – Solder pin – Angled – .464" / 11.8 mm –  
Precision machined contacts – Metal bracket

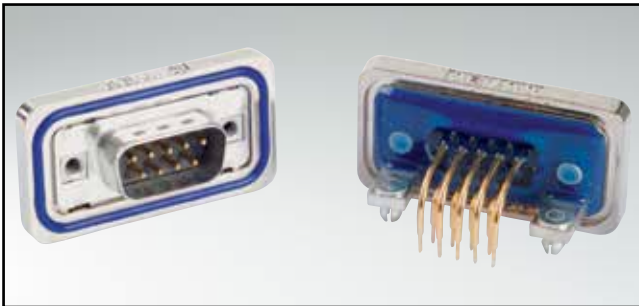

RoHS compliant – CSA listed, File No.: LR 115000-1 – UL listed, File No.: E 202784

## DESCRIPTION

- Mounting styles:
  - with 4-40 UNC or M3 threaded insert
  - with mounting bracket, PCB clip and 4-40 UNC or M3 threaded insert
- Quality class 3 (also available in quality class 1)
- Shell: brass tin plated
- Nickel plated die-cast frame (Black plastic frame on request)

## PRODUCT DRAWING



No. of pos.	A +0.30	B +0.30	C	D +0.25	E -0.30
09	21.10	39.40	25.00 <sup>+0.12</sup> <sub>-0.13</sub>	16.79	5.82
15	21.10	47.70	33.30 <sup>+0.15</sup> <sub>-0.10</sub>	25.12	5.82
25	21.10	61.40	47.04 <sup>+0.13</sup>	38.84	5.69
37	21.10	77.90	63.50 <sup>+0.13</sup>	55.30	5.69

PCB-Layout: Kat1kGUA

Mounting style: Threaded insert



Mounting style: PCB clip, threaded insert

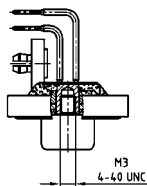

## ORDER DATA

Capacitance 180 pF

PLUG CONNECTOR			PLUG CONNECTOR		
No. of pos.	Mounting style	Part Number	No. of pos.	Mounting style	Part Number
09	M3 Threaded insert	6STF09PAZ01S10X	09	PCB clip / M3 Threaded insert	6STF09PAZ01S30X
15	M3 Threaded insert	6STF15PAZ01S10X	15	PCB clip / M3 Threaded insert	6STF15PAZ01S30X
25	M3 Threaded insert	6STF25PAZ01S10X	25	PCB clip / M3 Threaded insert	6STF25PAZ01S30X
37	M3 Threaded insert	6STF37PAZ01S10X	37	PCB clip / M3 Threaded insert	6STF37PAZ01S30X
09	4-40 UNC Threaded insert	6STF09PAZ01S20X	09	PCB clip / 4-40 UNC Threaded insert	6STF09PAZ01S40X
15	4-40 UNC Threaded insert	6STF15PAZ01S20X	15	PCB clip / 4-40 UNC Threaded insert	6STF15PAZ01S40X
25	4-40 UNC Threaded insert	6STF25PAZ01S20X	25	PCB clip / 4-40 UNC Threaded insert	6STF25PAZ01S40X
37	4-40 UNC Threaded insert	6STF37PAZ01S20X	37	PCB clip / 4-40 UNC Threaded insert	6STF37PAZ01S40X

PCB clip .122" / 3.1 ± .004" / 0.10 mm hole diameter and .063" / 1.6 mm circuit board thickness

# IP67 C-FILTER D-SUB STANDARD

Plug connector – Solder pin – Angled – .464" / 11.8 mm –

Precision machined contacts – Metal bracket

## ORDER DATA

### Capacitance 370 pF

PLUG CONNECTOR			PLUG CONNECTOR		
No. of pos.	Mounting style	Part Number	No. of pos.	Mounting style	Part Number
09	M3 Threaded insert	6STF09PAZ03S10X	09	PCB clip / M3 Threaded insert	6STF09PAZ03S30X
15	M3 Threaded insert	6STF15PAZ03S10X	15	PCB clip / M3 Threaded insert	6STF15PAZ03S30X
25	M3 Threaded insert	6STF25PAZ03S10X	25	PCB clip / M3 Threaded insert	6STF25PAZ03S30X
37	M3 Threaded insert	6STF37PAZ03S10X	37	PCB clip / M3 Threaded insert	6STF37PAZ03S30X
09	4-40 UNC Threaded insert	6STF09PAZ03S20X	09	PCB clip / 4-40 UNC Threaded insert	6STF09PAZ03S40X
15	4-40 UNC Threaded insert	6STF15PAZ03S20X	15	PCB clip / 4-40 UNC Threaded insert	6STF15PAZ03S40X
25	4-40 UNC Threaded insert	6STF25PAZ03S20X	25	PCB clip / 4-40 UNC Threaded insert	6STF25PAZ03S40X
37	4-40 UNC Threaded insert	6STF37PAZ03S20X	37	PCB clip / 4-40 UNC Threaded insert	6STF37PAZ03S40X

### Capacitance 830 pF

PLUG CONNECTOR			PLUG CONNECTOR		
No. of pos.	Mounting style	Part Number	No. of pos.	Mounting style	Part Number
09	M3 Threaded insert	6STF09PAZ04S10X	09	PCB clip / M3 Threaded insert	6STF09PAZ04S30X
15	M3 Threaded insert	6STF15PAZ04S10X	15	PCB clip / M3 Threaded insert	6STF15PAZ04S30X
25	M3 Threaded insert	6STF25PAZ04S10X	25	PCB clip / M3 Threaded insert	6STF25PAZ04S30X
37	M3 Threaded insert	6STF37PAZ04S10X	37	PCB clip / M3 Threaded insert	6STF37PAZ04S30X
09	4-40 UNC Threaded insert	6STF09PAZ04S20X	09	PCB clip / 4-40 UNC Threaded insert	6STF09PAZ04S40X
15	4-40 UNC Threaded insert	6STF15PAZ04S20X	15	PCB clip / 4-40 UNC Threaded insert	6STF15PAZ04S40X
25	4-40 UNC Threaded insert	6STF25PAZ04S20X	25	PCB clip / 4-40 UNC Threaded insert	6STF25PAZ04S40X
37	4-40 UNC Threaded insert	6STF37PAZ04S20X	37	PCB clip / 4-40 UNC Threaded insert	6STF37PAZ04S40X

### Capacitance 1300 pF

PLUG CONNECTOR			PLUG CONNECTOR		
No. of pos.	Mounting style	Part Number	No. of pos.	Mounting style	Part Number
09	M3 Threaded insert	6STF09PAZ05S10X	09	PCB clip / M3 Threaded insert	6STF09PAZ05S30X
15	M3 Threaded insert	6STF15PAZ05S10X	15	PCB clip / M3 Threaded insert	6STF15PAZ05S30X
25	M3 Threaded insert	6STF25PAZ05S10X	25	PCB clip / M3 Threaded insert	6STF25PAZ05S30X
37	M3 Threaded insert	6STF37PAZ05S10X	37	PCB clip / M3 Threaded insert	6STF37PAZ05S30X
09	4-40 UNC Threaded insert	6STF09PAZ05S20X	09	PCB clip / 4-40 UNC Threaded insert	6STF09PAZ05S40X
15	4-40 UNC Threaded insert	6STF15PAZ05S20X	15	PCB clip / 4-40 UNC Threaded insert	6STF15PAZ05S40X
25	4-40 UNC Threaded insert	6STF25PAZ05S20X	25	PCB clip / 4-40 UNC Threaded insert	6STF25PAZ05S40X
37	4-40 UNC Threaded insert	6STF37PAZ05S20X	37	PCB clip / 4-40 UNC Threaded insert	6STF37PAZ05S40X

PCB clip .122" / 3.1 ± .004" / 0.10 mm hole diameter and .063" / 1.6 mm circuit board thickness

# IP67 C-FILTER D-SUB STANDARD

Plug connector – Solder cup – Precision machined contacts –  
For wire size AWG 26 – Front mounting

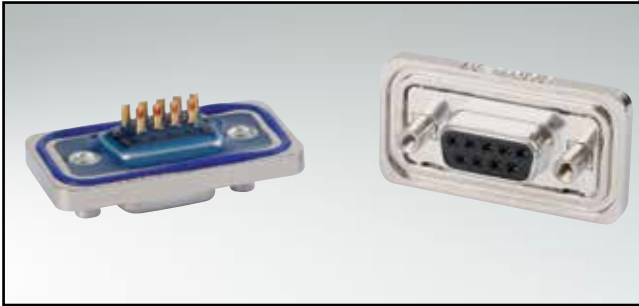

RoHS compliant – CSA listed, File No.: LR 115000-1 – UL listed, File No.: E 202784

## DESCRIPTION

- Suitable for wire size **AWG 26** (AWG 20 available on request)
- Mounting style:  
with M3 or 4-40 UNC front spacer
- Quality class 3 (also available in quality class 1)
- Shell: brass tin plated
- Nickel plated die-cast frame  
(Black plastic frame on request)

## PRODUCT DRAWING

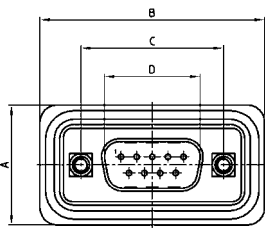

No. of pos.	A +0.30	B +0.30	C	D +0.25	E -0.30
09	21.10	39.40	25.00 <sup>+0.12</sup> <sub>-0.13</sub>	16.79	5.82
15	21.10	47.70	33.30 <sup>+0.15</sup> <sub>-0.10</sub>	25.12	5.82
25	21.10	61.40	47.04 <sup>+0.13</sup> <sub>-0.13</sub>	38.84	5.69
37	21.10	77.90	63.50 <sup>+0.13</sup> <sub>-0.13</sub>	55.30	5.69
50	23.90	75.50	61.10 <sup>+0.14</sup> <sub>-0.11</sub>	52.68	5.69

Mounting style: Threaded lock

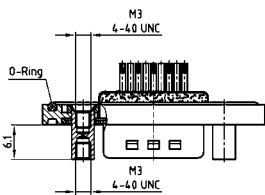

9-37 pos.

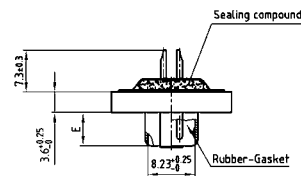

50 pos.

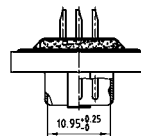

## ORDER DATA

Capacitance 180 pF

PLUG CONNECTOR			PLUG CONNECTOR		
No. of pos.	Mounting style M3	Part Number	No. of pos.	Mounting style 4-40 UNC	Part Number
09	Front spacer	6STF09PAM01B40X	09	Front spacer	6STF09PAM01B50X
15	Front spacer	6STF15PAM01B40X	15	Front spacer	6STF15PAM01B50X
25	Front spacer	6STF25PAM01B40X	25	Front spacer	6STF25PAM01B50X
37	Front spacer	6STF37PAM01B40X	37	Front spacer	6STF37PAM01B50X
50	Front spacer	6STF50PAM01B40X	50	Front spacer	6STF50PAM01B50X

# IP67 C-FILTER D-SUB STANDARD

Plug connector – Solder cup – Precision machined contacts –

For wire size AWG 26 – Front mounting

## ORDER DATA

### Capacitance 370 pF

PLUG CONNECTOR			PLUG CONNECTOR		
No. of pos.	Mounting style M3	Part Number	No. of pos.	Mounting style 4-40 UNC	Part Number
09	Front spacer	6STF09PAM03B40X	09	Front spacer	6STF09PAM03B50X
15	Front spacer	6STF15PAM03B40X	15	Front spacer	6STF15PAM03B50X
25	Front spacer	6STF25PAM03B40X	25	Front spacer	6STF25PAM03B50X
37	Front spacer	6STF37PAM03B40X	37	Front spacer	6STF37PAM03B50X
50	Front spacer	6STF50PAM03B40X	50	Front spacer	6STF50PAM03B50X

### Capacitance 830 pF

PLUG CONNECTOR			PLUG CONNECTOR		
No. of pos.	Mounting style M3	Part Number	No. of pos.	Mounting style 4-40 UNC	Part Number
09	Front spacer	6STF09PAM04B40X	09	Front spacer	6STF09PAM04B50X
15	Front spacer	6STF15PAM04B40X	15	Front spacer	6STF15PAM04B50X
25	Front spacer	6STF25PAM04B40X	25	Front spacer	6STF25PAM04B50X
37	Front spacer	6STF37PAM04B40X	37	Front spacer	6STF37PAM04B50X
50	Front spacer	6STF50PAM04B40X	50	Front spacer	6STF50PAM04B50X

### Capacitance 1300 pF

PLUG CONNECTOR			PLUG CONNECTOR		
No. of pos.	Mounting style M3	Part Number	No. of pos.	Mounting style 4-40 UNC	Part Number
09	Front spacer	6STF09PAM05B40X	09	Front spacer	6STF09PAM05B50X
15	Front spacer	6STF15PAM05B40X	15	Front spacer	6STF15PAM05B50X
25	Front spacer	6STF25PAM05B40X	25	Front spacer	6STF25PAM05B50X
37	Front spacer	6STF37PAM05B40X	37	Front spacer	6STF37PAM05B50X
50	Front spacer	6STF50PAM05B40X	50	Front spacer	6STF50PAM05B50X



# IP67 C-FILTER D-SUB STANDARD

Plug connector – Solder cup – Precision machined contacts –  
For wire size AWG 26 – For hood assembly

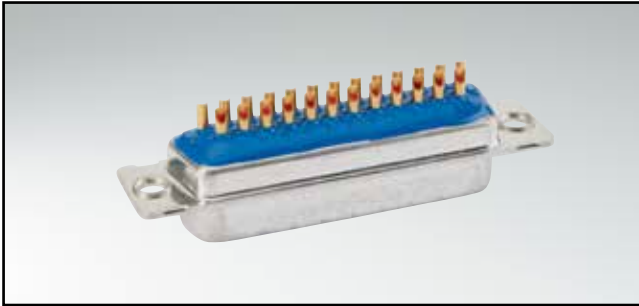

RoHS compliant – CSA listed, File No.: LR 115000-1 – UL listed, File No.: E 202784

## DESCRIPTION

- Suitable for wire size AWG 26 (AWG 20 available on request)
- Mounting style:  
with through-hole  $\varnothing$  .118" / 3,0 mm
- Quality class 3 (also available in quality class 1)
- Shell: brass tin plated

## PRODUCT DRAWING

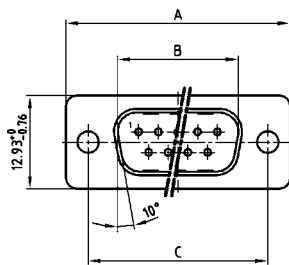

Mounting style: Through-hole

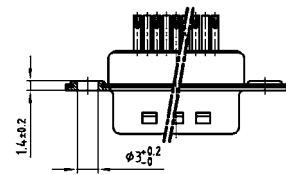

No. of pos.	A -0.76	B +0.25	C	D -0.30
09	31.19	16.79	25.00 <sup>+0.12</sup> <sub>-0.13</sub>	6.12
15	39.52	25.12	33.30 <sup>+0.15</sup> <sub>-0.10</sub>	6.12
25	53.42	38.84	47.04 <sup>+0.13</sup>	5.99
37	69.70	55.30	63.50 <sup>+0.13</sup>	5.99
50	67.31	52.68	61.10 <sup>+0.14</sup> <sub>-0.11</sub>	5.99

9-37 pos.

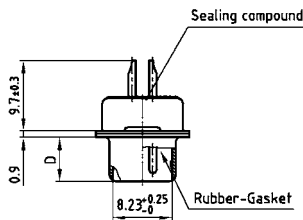

50 pos.

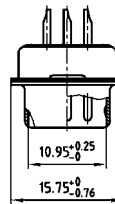

## ORDER DATA

Capacitance 180 pF

PLUG CONNECTOR		
No. of pos.	Mounting style	Part Number
09	Through-hole	4STF09PAM01A10X
15	Through-hole	4STF15PAM01A10X
25	Through-hole	4STF25PAM01A10X
37	Through-hole	4STF37PAM01A10X
50	Through-hole	4STF50PAM01A10X

## IP67 C-FILTER D-SUB STANDARD

Plug connector – Solder cup – Precision machined contacts –

For wire size AWG 26 – For hood assembly

### ORDER DATA

#### Capacitance 370 pF

##### PLUG CONNECTOR

No. of pos.	Mounting style	Part Number
09	Through-hole	4STF09PAM03A10X
15	Through-hole	4STF15PAM03A10X
25	Through-hole	4STF25PAM03A10X
37	Through-hole	4STF37PAM03A10X
50	Through-hole	4STF50PAM03A10X

#### Capacitance 830 pF

##### PLUG CONNECTOR

No. of pos.	Mounting style	Part Number
09	Through-hole	4STF09PAM04A10X
15	Through-hole	4STF15PAM04A10X
25	Through-hole	4STF25PAM04A10X
37	Through-hole	4STF37PAM04A10X
50	Through-hole	4STF50PAM04A10X

#### Capacitance 1300 pF

##### PLUG CONNECTOR

No. of pos.	Mounting style	Part Number
09	Through-hole	4STF09PAM05A10X
15	Through-hole	4STF15PAM05A10X
25	Through-hole	4STF25PAM05A10X
37	Through-hole	4STF37PAM05A10X
50	Through-hole	4STF50PAM05A10X

# IP67 C-FILTER D-SUB HIGH DENSITY

Plug connector – Solder pin – Straight – Precision machined contacts

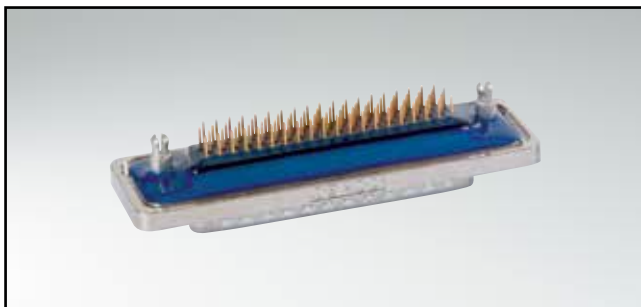

RoHS compliant – CSA listed, File No.: LR 115000-1 – UL listed, File No.: E 202784

## DESCRIPTION

- Mounting styles:
  - with 4-40 UNC or M3 threaded insert
  - with 4-40 UNC or M3 threaded rear spacer with PCB clip
- Quality class 3 (also available in quality class 1)
- Shell: brass tin plated
- Nickel plated die-cast frame  
(Black plastic frame on request)

## PRODUCT DRAWING

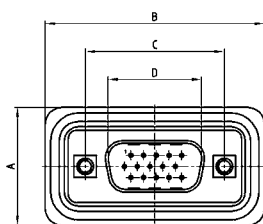

No. of pos.	A +0.30	B +0.30	C	D +0.25	E -0.30
15	21.10	39.40	25.00 <sup>+0.12</sup> <sub>-0.13</sub>	16.79	5.82
26	21.10	47.70	33.30 <sup>+0.15</sup> <sub>-0.10</sub>	25.12	5.82
44	21.10	61.40	47.04 <sup>+0.13</sup>	38.84	5.69
62	21.10	77.90	63.50 <sup>+0.13</sup>	55.30	5.69

PCB-Layout: Kat1kFWA / Kat1iU0A

Mounting style: Threaded insert

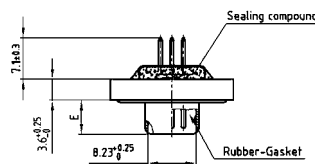
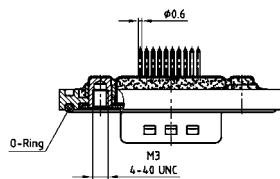

Mounting style: Threaded rear spacer with PCB clip

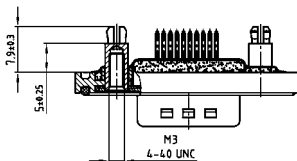

## ORDER DATA

Capacitance 180 pF

PLUG CONNECTOR			PLUG CONNECTOR		
No. of pos.	Mounting style	Part Number	No. of pos.	Mounting style	Part Number
15	M3 Threaded insert	6HDF15PAR01B20X	15	M3 Threaded rear spacer PCB clip	6HDF15PAR01E10X
26	M3 Threaded insert	6HDF26PAR01B20X	26	M3 Threaded rear spacer PCB clip	6HDF26PAR01E10X
44	M3 Threaded insert	6HDF44PAR01B20X	44	M3 Threaded rear spacer PCB clip	6HDF44PAR01E10X
62	M3 Threaded insert	6HDF62PAR01B20X	62	M3 Threaded rear spacer PCB clip	6HDF62PAR01E10X
15	4-40 UNC Threaded insert	6HDF15PAR01B30X	15	4-40 UNC Threaded rear spacer PCB clip	6HDF15PAR01E20X
26	4-40 UNC Threaded insert	6HDF26PAR01B30X	26	4-40 UNC Threaded rear spacer PCB clip	6HDF26PAR01E20X
44	4-40 UNC Threaded insert	6HDF44PAR01B30X	44	4-40 UNC Threaded rear spacer PCB clip	6HDF44PAR01E20X
62	4-40 UNC Threaded insert	6HDF62PAR01B30X	62	4-40 UNC Threaded rear spacer PCB clip	6HDF62PAR01E20X

PCB clip .122"/3.1 ± .004"/0.10 mm hole diameter and .063"/1.6 mm circuit board thickness

# IP67 C-FILTER D-SUB HIGH DENSITY

Plug connector – Solder pin – Straight – Precision machined contacts

## ORDER DATA

### Capacitance 370 pF

PLUG CONNECTOR			PLUG CONNECTOR		
No. of pos.	Mounting style	Part Number	No. of pos.	Mounting style	Part Number
15	M3 Threaded insert	6HDF15PAR03B20X	15	M3 Threaded rear spacer PCB clip	6HDF15PAR03E10X
26	M3 Threaded insert	6HDF26PAR03B20X	26	M3 Threaded rear spacer PCB clip	6HDF26PAR03E10X
44	M3 Threaded insert	6HDF44PAR03B20X	44	M3 Threaded rear spacer PCB clip	6HDF44PAR03E10X
62	M3 Threaded insert	6HDF62PAR03B20X	62	M3 Threaded rear spacer PCB clip	6HDF62PAR03E10X
15	4-40 UNC Threaded insert	6HDF15PAR03B30X	15	4-40 UNC Threaded rear spacer PCB clip	6HDF15PAR03E20X
26	4-40 UNC Threaded insert	6HDF26PAR03B30X	26	4-40 UNC Threaded rear spacer PCB clip	6HDF26PAR03E20X
44	4-40 UNC Threaded insert	6HDF44PAR03B30X	44	4-40 UNC Threaded rear spacer PCB clip	6HDF44PAR03E20X
62	4-40 UNC Threaded insert	6HDF62PAR03B30X	62	4-40 UNC Threaded rear spacer PCB clip	6HDF62PAR03E20X

### Capacitance 830 pF

PLUG CONNECTOR			PLUG CONNECTOR		
No. of pos.	Mounting style	Part Number	No. of pos.	Mounting style	Part Number
15	M3 Threaded insert	6HDF15PAR04B20X	15	M3 Threaded rear spacer PCB clip	6HDF15PAR04E10X
26	M3 Threaded insert	6HDF26PAR04B20X	26	M3 Threaded rear spacer PCB clip	6HDF26PAR04E10X
44	M3 Threaded insert	6HDF44PAR04B20X	44	M3 Threaded rear spacer PCB clip	6HDF44PAR04E10X
62	M3 Threaded insert	6HDF62PAR04B20X	62	M3 Threaded rear spacer PCB clip	6HDF62PAR04E10X
15	4-40 UNC Threaded insert	6HDF15PAR04B30X	15	4-40 UNC Threaded rear spacer PCB clip	6HDF15PAR04E20X
26	4-40 UNC Threaded insert	6HDF26PAR04B30X	26	4-40 UNC Threaded rear spacer PCB clip	6HDF26PAR04E20X
44	4-40 UNC Threaded insert	6HDF44PAR04B30X	44	4-40 UNC Threaded rear spacer PCB clip	6HDF44PAR04E20X
62	4-40 UNC Threaded insert	6HDF62PAR04B30X	62	4-40 UNC Threaded rear spacer PCB clip	6HDF62PAR04E20X

PCB clip .122"/3.1 ± .004"/0.10 mm hole diameter and .063"/1.6 mm circuit board thickness

# IP67 C-FILTER D-SUB HIGH DENSITY

Plug connector – Solder pin – Angled – .220" / 5.6 mm –  
Precision machined contacts – Metal bracket

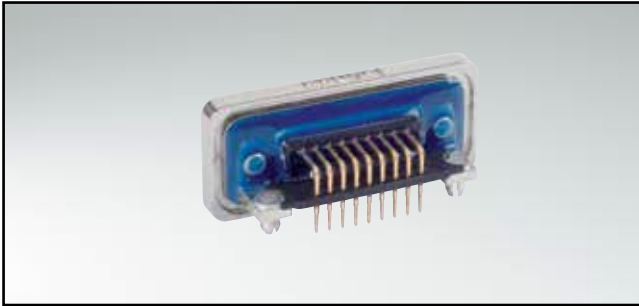

RoHS compliant – CSA listed, File No.: LR 115000-1 – UL listed, File No.: E 202784

## DESCRIPTION

- Mounting styles:
  - with 4-40 UNC or M3 threaded insert
  - with mounting bracket, PCB clip and 4-40 UNC or M3 threaded insert
- Quality class 3 (also available in quality class 1)
- Shell: brass tin plated
- Nickel plated die-cast frame (Black plastic frame on request)

## PRODUCT DRAWING

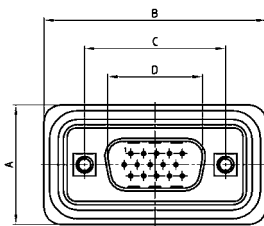

No. of pos.	A +0.30	B +0.30	C	D +0.25	E -0.30
15	21.10	39.40	25.00 <sup>+0.12</sup> <sub>-0.13</sub>	16.79	5.82
26	21.10	47.70	33.30 <sup>+0.15</sup> <sub>-0.10</sub>	25.12	5.82
44	21.10	61.40	47.04 <sup>+0.13</sup>	38.84	5.69
62	21.10	77.90	63.50 <sup>+0.13</sup>	55.30	5.69

PCB-Layout: Kat1kgWA

Mounting style: Threaded insert

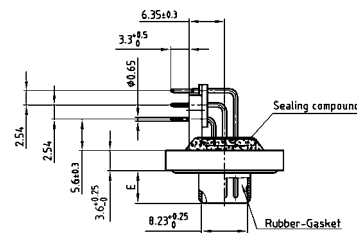
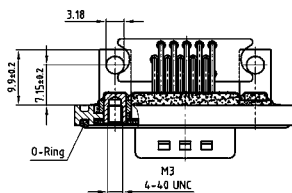

Mounting style: PCB clip, threaded insert

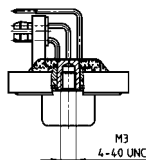

## ORDER DATA

### Capacitance 180 pF

PLUG CONNECTOR			PLUG CONNECTOR		
No. of pos.	Mounting style	Part Number	No. of pos.	Mounting style	Part Number
15	M3 Threaded insert	6HDF15PAY01R10X	15	PCB clip / M3 Threaded insert	6HDF15PAY01R30X
26	M3 Threaded insert	6HDF26PAY01R10X	26	PCB clip / M3 Threaded insert	6HDF26PAY01R30X
44	M3 Threaded insert	6HDF44PAY01R10X	44	PCB clip / M3 Threaded insert	6HDF44PAY01R30X
62	M3 Threaded insert	6HDF62PAY01R10X	62	PCB clip / M3 Threaded insert	6HDF62PAY01R30X
15	4-40 UNC Threaded insert	6HDF15PAY01R20X	15	PCB clip / 4-40 UNC Threaded insert	6HDF15PAY01R40X
26	4-40 UNC Threaded insert	6HDF26PAY01R20X	26	PCB clip / 4-40 UNC Threaded insert	6HDF26PAY01R40X
44	4-40 UNC Threaded insert	6HDF44PAY01R20X	44	PCB clip / 4-40 UNC Threaded insert	6HDF44PAY01R40X
62	4-40 UNC Threaded insert	6HDF62PAY01R20X	62	PCB clip / 4-40 UNC Threaded insert	6HDF62PAY01R40X

PCB clip .122" / 3.1 ± .004" / 0.10 mm hole diameter and .063" / 1.6 mm circuit board thickness

# IP67 C-FILTER D-SUB HIGH DENSITY

Plug connector – Solder pin – Angled – .220" / 5.6 mm –

Precision machined contacts – Metal bracket

## ORDER DATA

### Capacitance 370 pF

PLUG CONNECTOR			PLUG CONNECTOR		
No. of pos.	Mounting style	Part Number	No. of pos.	Mounting style	Part Number
15	M3 Threaded insert	6HDF15PAY03R10X	15	PCB clip / M3 Threaded insert	6HDF15PAY03R30X
26	M3 Threaded insert	6HDF26PAY03R10X	26	PCB clip / M3 Threaded insert	6HDF26PAY03R30X
44	M3 Threaded insert	6HDF44PAY03R10X	44	PCB clip / M3 Threaded insert	6HDF44PAY03R30X
62	M3 Threaded insert	6HDF62PAY03R10X	62	PCB clip / M3 Threaded insert	6HDF62PAY03R30X
15	4-40 UNC Threaded insert	6HDF15PAY03R20X	15	PCB clip / 4-40 UNC Threaded insert	6HDF15PAY03R40X
26	4-40 UNC Threaded insert	6HDF26PAY03R20X	26	PCB clip / 4-40 UNC Threaded insert	6HDF26PAY03R40X
44	4-40 UNC Threaded insert	6HDF44PAY03R20X	44	PCB clip / 4-40 UNC Threaded insert	6HDF44PAY03R40X
62	4-40 UNC Threaded insert	6HDF62PAY03R20X	62	PCB clip / 4-40 UNC Threaded insert	6HDF62PAY03R40X

### Capacitance 830 pF

PLUG CONNECTOR			PLUG CONNECTOR		
No. of pos.	Mounting style	Part Number	No. of pos.	Mounting style	Part Number
15	M3 Threaded insert	6HDF15PAY04R10X	15	PCB clip / M3 Threaded insert	6HDF15PAY04R30X
26	M3 Threaded insert	6HDF26PAY04R10X	26	PCB clip / M3 Threaded insert	6HDF26PAY04R30X
44	M3 Threaded insert	6HDF44PAY04R10X	44	PCB clip / M3 Threaded insert	6HDF44PAY04R30X
62	M3 Threaded insert	6HDF62PAY04R10X	62	PCB clip / M3 Threaded insert	6HDF62PAY04R30X
15	4-40 UNC Threaded insert	6HDF15PAY04R20X	15	PCB clip / 4-40 UNC Threaded insert	6HDF15PAY04R40X
26	4-40 UNC Threaded insert	6HDF26PAY04R20X	26	PCB clip / 4-40 UNC Threaded insert	6HDF26PAY04R40X
44	4-40 UNC Threaded insert	6HDF44PAY04R20X	44	PCB clip / 4-40 UNC Threaded insert	6HDF44PAY04R40X
62	4-40 UNC Threaded insert	6HDF62PAY04R20X	62	PCB clip / 4-40 UNC Threaded insert	6HDF62PAY04R40X

PCB clip .122" / 3.1 ± .004" / 0.10 mm hole diameter and .063" / 1.6 mm circuit board thickness

# TECHNICAL DATA

<b>Materials</b>	<b>Filter D-SUB Standard IP67 9, 15, 25, 37 and 50 position</b>	<b>Filter D-SUB High Density IP67 15, 26, 44, and 62 position</b>
Insulator	Polyester GF UL94 V-0	
Contacts	CU alloy	
Contact plating	Gold plated over nickel, solder area tin plated (PCB)	
Shell	Brass tin plated	
<b>Mechanical and electrical characteristics</b>		
Dielectric with standing voltage	Standard 424 VDC	Standard 300 VDC
Working voltage	100 VDC Depending on isolation coordination (refer to DIN VDE 0110/IEC 664-1)	100 VDC
Contact resistance	Max. 10 mΩ prior to stressing, Δ R max. 10 mΩ after stressing per DIN 41652, Part 2	
Insulation resistance	≥ 1GΩ	
Current rating	7.5 A (UL) / 5 A (CSA, VDE)	3 A (UL, VDE) / 2.5 A (CSA)
Voltage surge 10/700μs	Standard 300 V	Standard 300 V
Temperature working range	-25°C to +105°C	-25°C to +85°C
Capacitor values For other capacitance values please contact the factory.	180 pF ± 20% tolerance 370 pF ± 20% tolerance 830 pF ± 20% tolerance 1300 pF ± 20% tolerance	180 pF ± 20% tolerance 370 pF ± 20% tolerance 830 pF ± 20% tolerance
Mating and unmating forces	9 pos. ≤ 30 N 15 pos. ≤ 50 N 25 pos. ≤ 83 N 37 pos. ≤ 123 N 50 pos. ≤ 167 N	15 pos. ≤ 50 N 26 pos. ≤ 84 N 44 pos. ≤ 120 N 62 pos. ≤ 170 N
Quality class	A = Quality class 3 = 50 mating cycles B = Quality class 2 = 200 mating cycles C = Quality class 1 = 500 mating cycles	
Degree of protection	Requirement according to IEC 60529 – IP67	

Technical specifications are subject to change without notice.

# INSERTION LOSS

## C-FILTER WITH PLANAR FILTER TECHNOLOGY

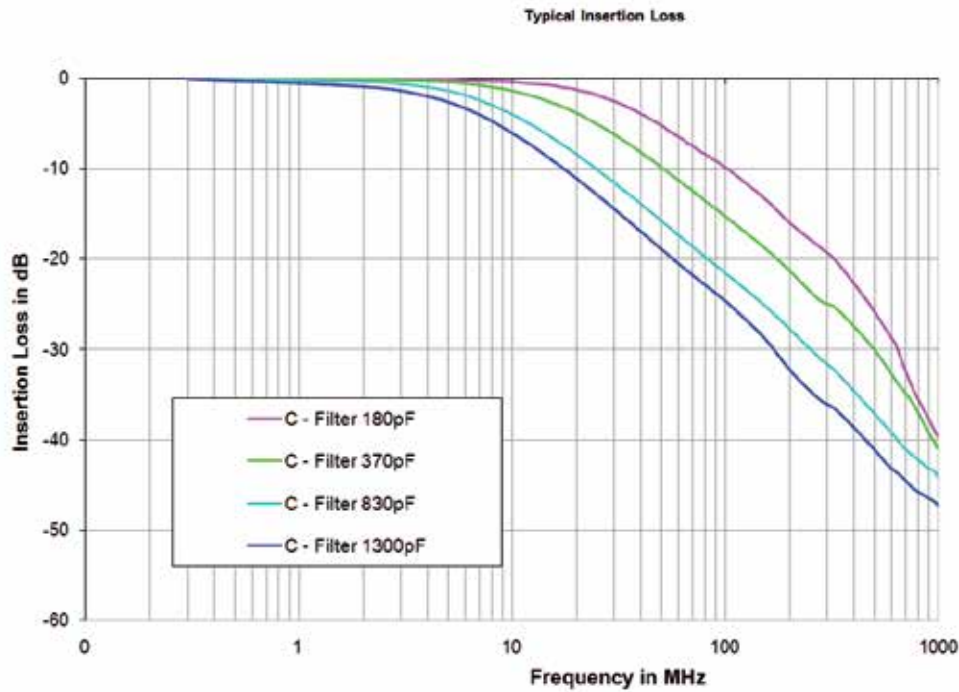

# SOLDER PROFILE

Connector Type	Preheating		Solder terminal dipping parameters	
	max. Temperature	Duration	max. Solder bath Temperature	max. Terminal Immersion Time
Filter D-SUB	100°C	30s	260°C	5s
Combo D-SUB Filter	120°C	120s	260°C	5s
Filter D-SUB Water Resistant	100°C	30s	240°C	5s
Combo D-SUB Water Resistant	120°C	120s	240°C	5s
D-SUB Water Resistant	120°C	120s	240°C	5s
D-SUB Solid Body Type Water Resistant	150°C	180s	265°C	8s
RJ45 Modular Jack Filtered	150°C	180s	265°C	8s
Filter Plates	150°C	180s	265°C	8s

Recommended wave-solder parameters for CONEC connectors.



# IP-CODE DEFINITIONS

1. Code figure	Definition	Remark
0	Not protected	
1	Protected against access to hazardous parts by the back of the hand. Protected against fixed foreign objects $\varnothing \geq 1.969''/50$ mm.	
2	Protected against access to hazardous parts with a finger. Protected against fixed foreign objects $\varnothing \geq .492''/12.5$ mm.	
3	Protected against access to hazardous parts with a tool. Protected against fixed foreign objects $\varnothing \geq .098''/2.5$ mm.	
4	Protected against access to hazardous parts with a wire. Protected against fixed foreign objects $\varnothing \geq .039''/1$ mm.	
5	Protected against access to hazardous parts with a wire. Dust protected.	Ingress of dust is not completely blocked. But dust may not penetrate to the extent that satisfactory operation of the device or safety is impaired.
6	Protected against access to hazardous parts with a wire. Dustproof. No ingress of dust.	

2. Code figure	Definition	Remark
0	Not protected	
1	Protected against dropper.	
2	Protected against dropper when the shell is tipped as much as 15°.	
3	Protected against spray water	Up to 60° of either side of the vertical, such spray water shall have no harmful effects.
4	Protected against splash water	On the shell from all directions, no harmful effects shall be incurred.
5	Protected against jets of water.	
6	Protected against strong jets of water.	
7	Protected against the effects of temporary submersion in water.	Water may not ingress in a volume that would cause harmful effects when the shell is submerged in water for 30 min at a depth of 1 m.
8	Protected against the effects of continuous submersion in water.	Water may not ingress in a volume that would cause harmful effects when the shell is continuously submerged in water under conditions agreed between manufacturer and user. However, these conditions must be more stringent than those described under code figure 7.
9k	Protected against water from high-pressure or steam cleaning.	

### Explanation to spray water protected (IP) systems and their environment.

This system, described in IEC 60529, was developed to represent standard values for respective protection:

- a) Contact with, and ingress of, fixed foreign objects
- b) The ingress of liquids to which the inside is to be exposed.

The first digit describes the level of protection for life, contacting objects and the intrusion of foreign bodies. The second digit describes the level of protection against the ingress of liquids. The larger the first and second digits are, the greater afforded protection is, e.g. IP55 must also meet the requirements of all lower protection levels, such as IP22, IP23, IP34 and IP54.

# MATING CONDITIONS

Float mount tolerance guide

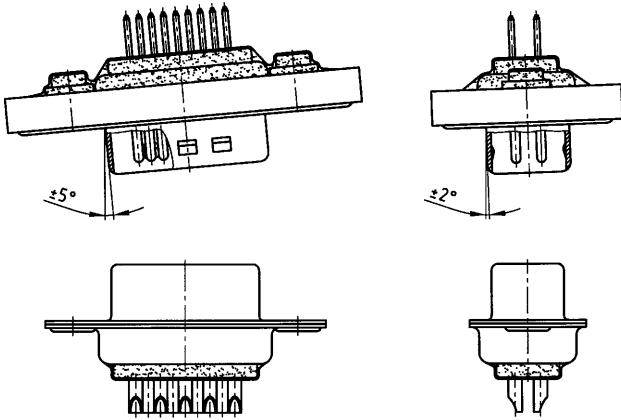

Rigid mount tolerance guide

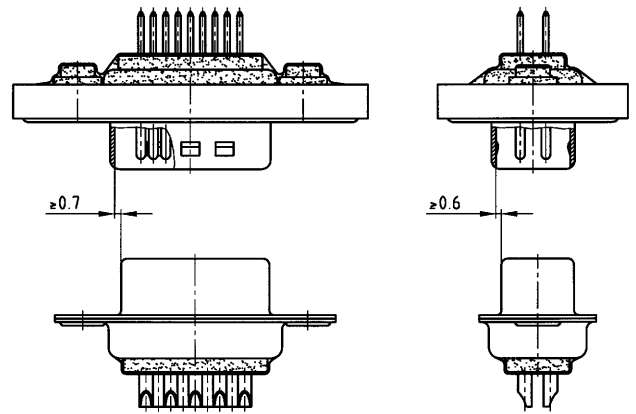

Rigid mount vertical to tolerance guide



## PANEL CUT-OUT

Rear panel mounting

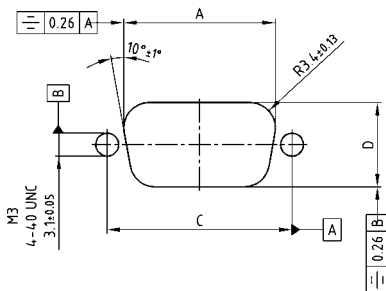

Front panel mounting

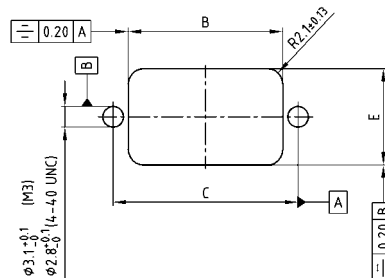

Shell size	A $\pm 0.1$	B $\pm 0.1$	C $\pm 0.1$	D $\pm 0.1$	E $\pm 0.1$
9	20.50	20.90	25.00	11.40	13.00
15	28.80	29.20	33.30	11.40	13.00
25	42.50	42.90	47.04	11.40	13.00
37	59.10	59.40	63.50	11.40	13.00
50	56.30	57.00	61.10	14.10	15.80

# PCB LAYOUT D-SUB STANDARD

Solder pin, straight – Without rear spacer PCB clip – Plug connector

9 POS.

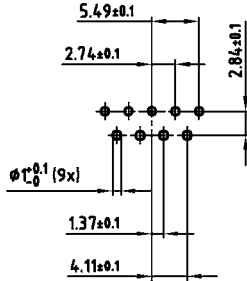

37 POS.

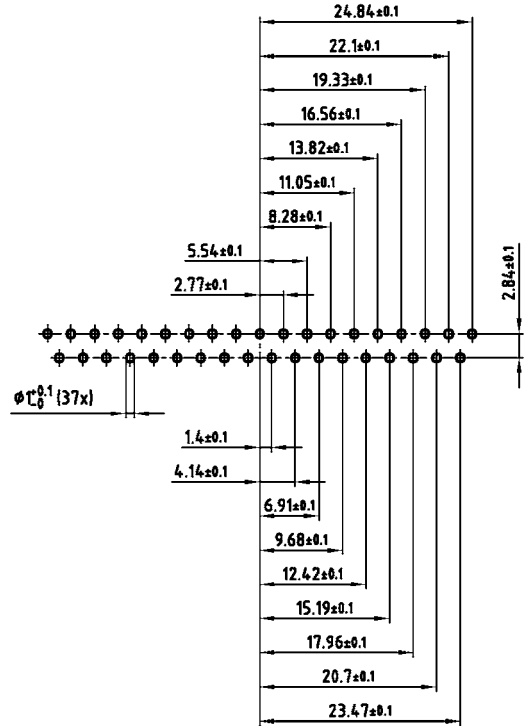

15 POS.



50 POS.

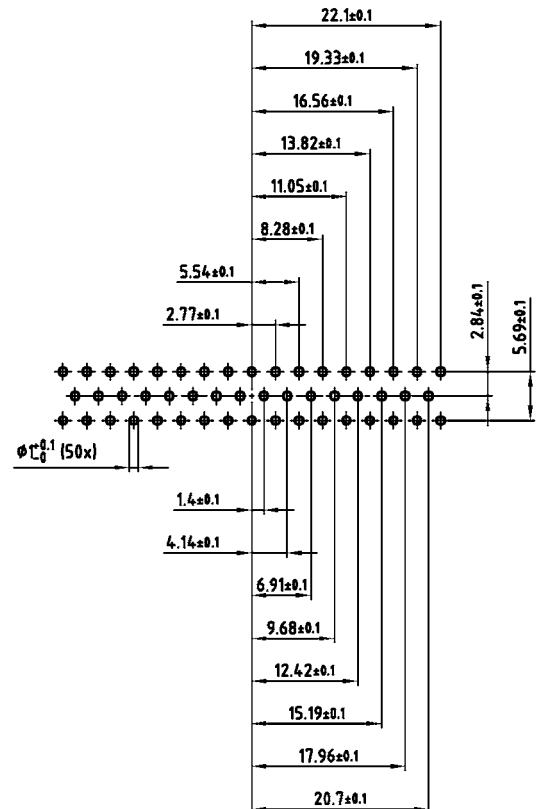

25 POS.

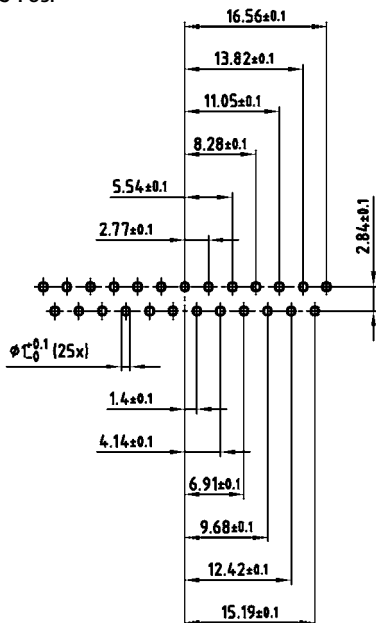

PCB layout Kat1 kFVA (View: component side)

# PCB LAYOUT D-SUB STANDARD

Solder pin, straight – With rear spacer PCB clip – Plug connector

9 POS.

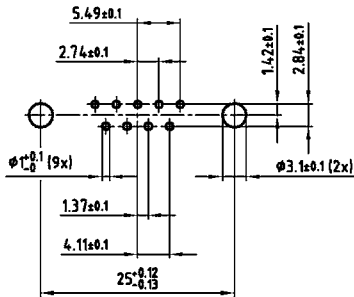

37 POS.



15 POS.

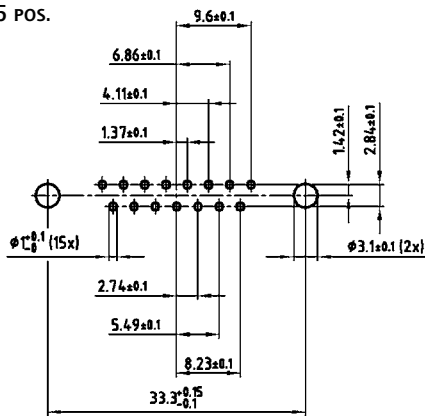

50 POS.



25 POS.

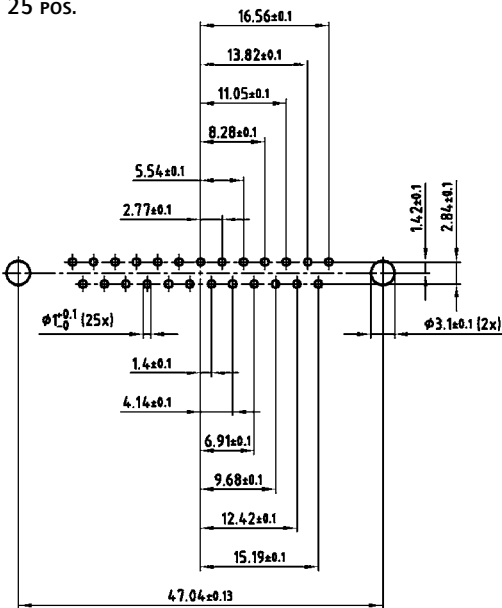

PCB layout Kat1kFUA (View: component side)

# PCB LAYOUT D-SUB STANDARD

Solder pin, angled .189" / 4.8 mm – Plug connector

9 POS.

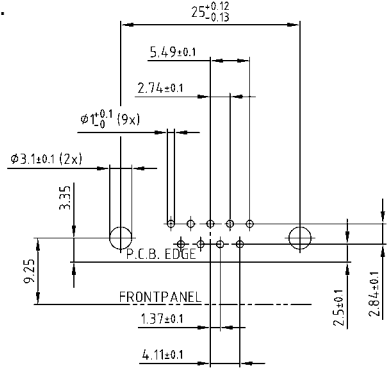

15 POS.

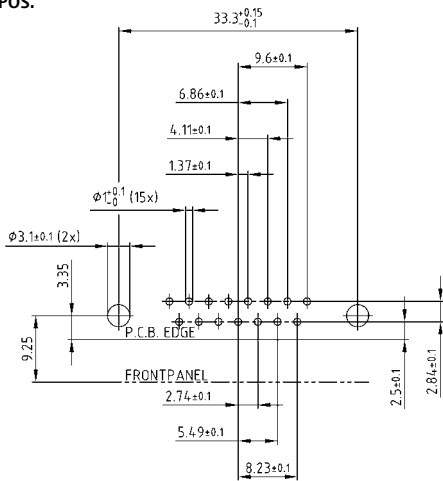

25 POS.



37 POS.

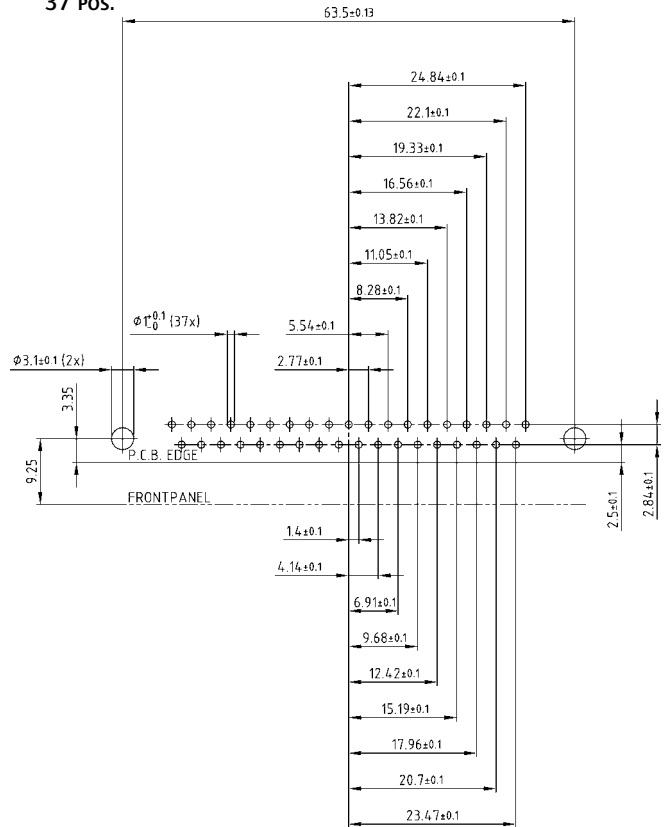

50 POS.

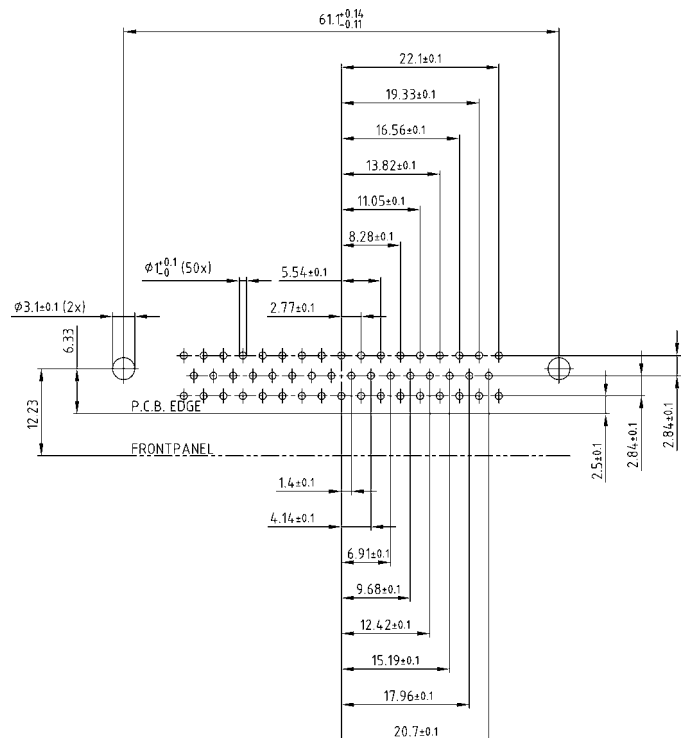

PCB layout Kat1kGSA (View: component side)

# PCB LAYOUT D-SUB STANDARD

Solder pin, angled .276" / 7.0 mm – Plug connector

9 pos.



15 pos.

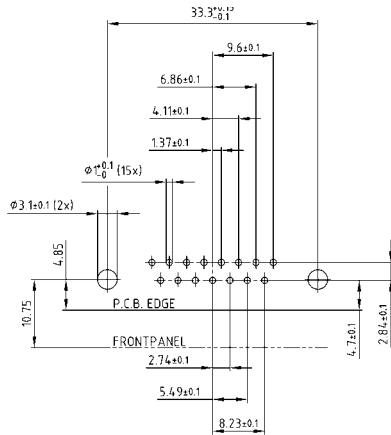

25 pos.

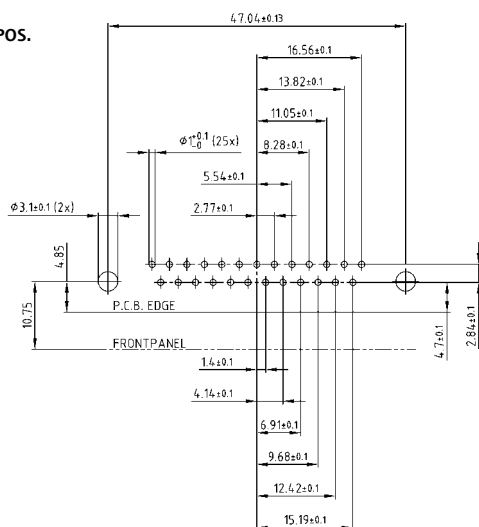

37 pos.

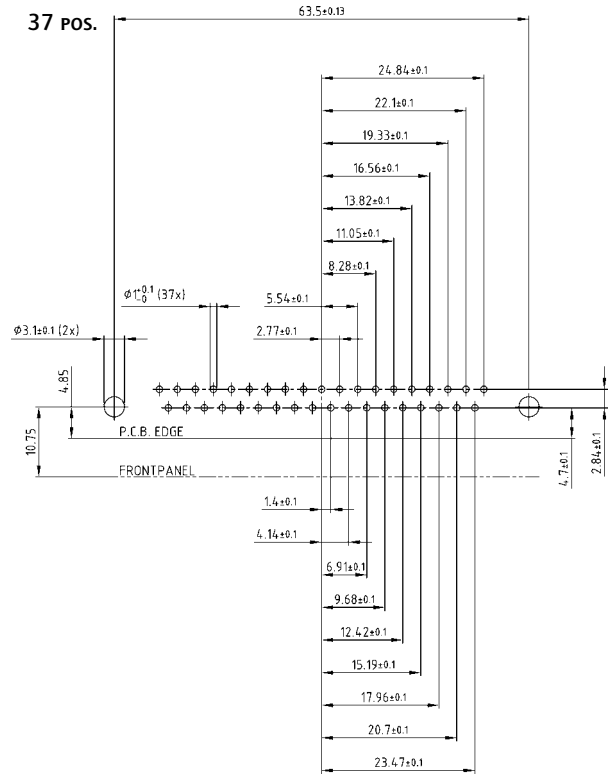

50 pos.

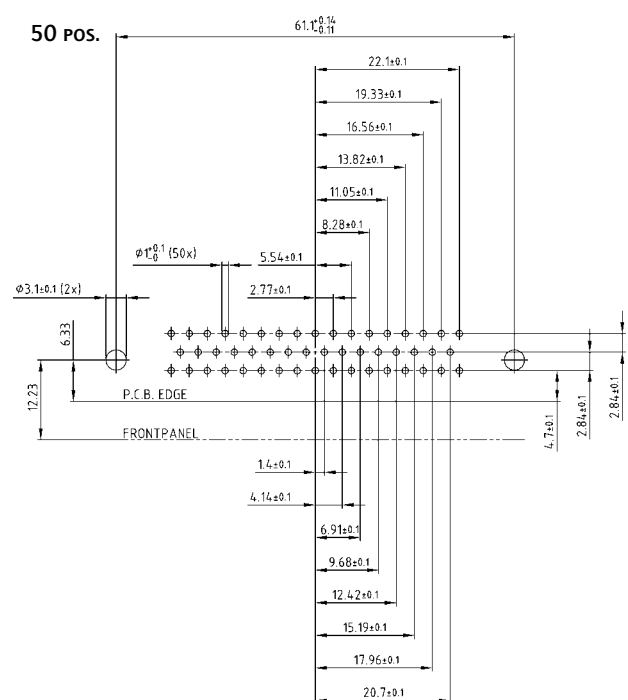

PCB layout Kat1 kGTA (View: component side)

# PCB LAYOUT D-SUB STANDARD

Solder pin, angled, .464" / 11.8 mm – Plug connector

9 pos.

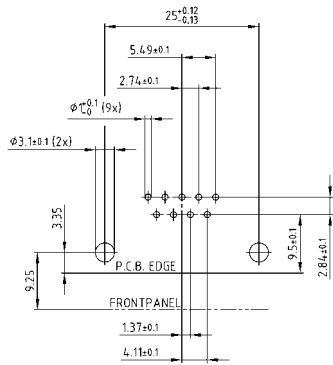

25 pos.



15 pos.



37 pos.

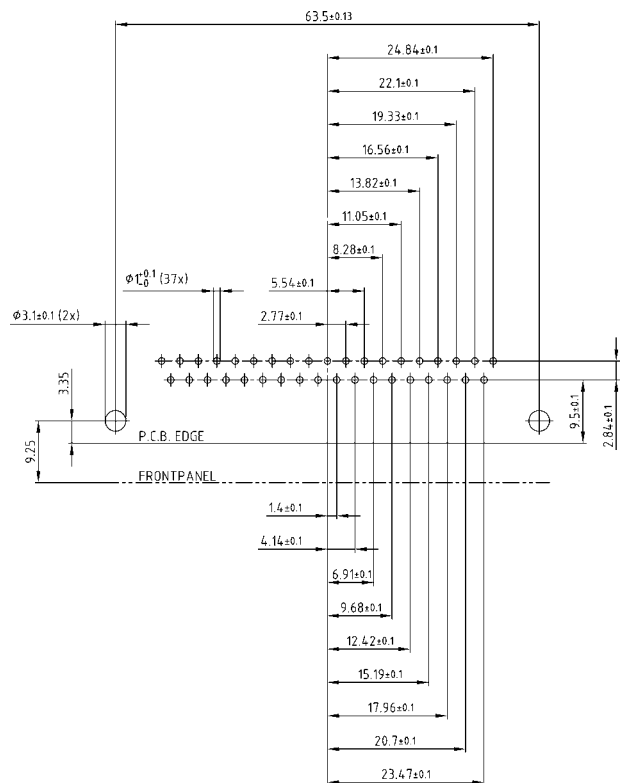

PCB layout Kat1 kGUA (View: component side)

# PCB LAYOUT D-SUB HIGH DENSITY

Solder pin, straight – Without rear spacer PCB clip – Plug connector

15 POS.



62 POS.

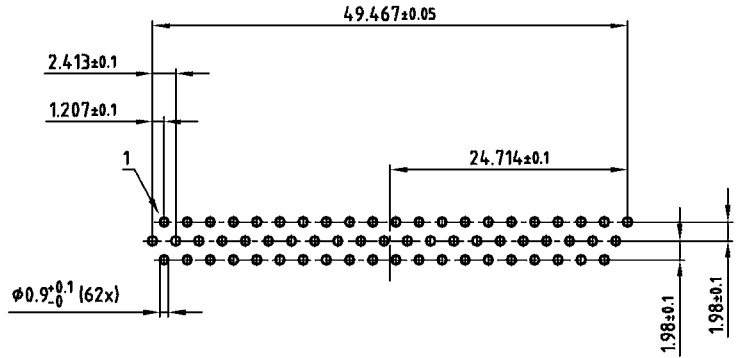

26 POS.

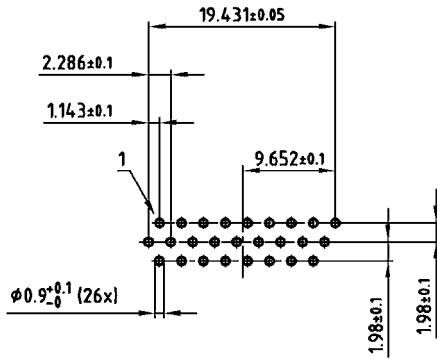

78 POS.

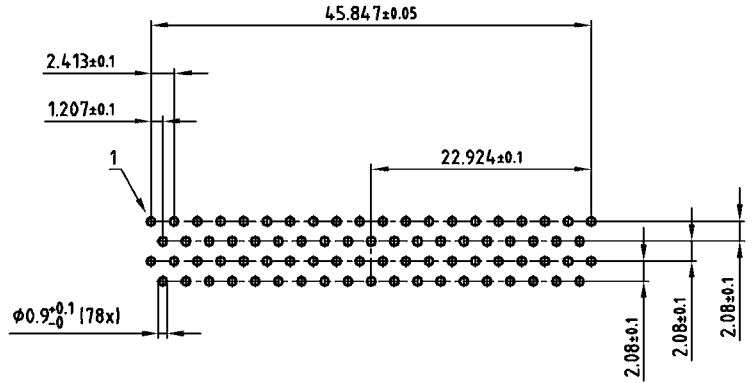

44 POS.

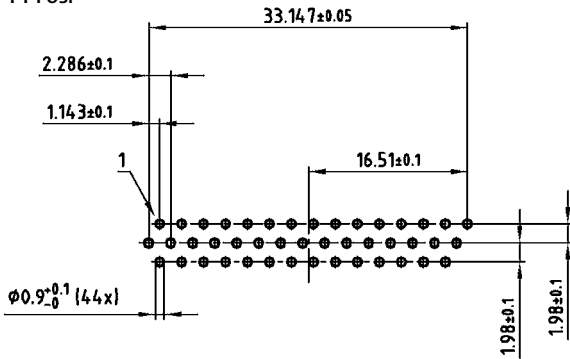

PCB layout Kat1 kFWA (View: component side)



# PCB LAYOUT D-SUB HIGH DENSITY

Solder pin, straight – With rear spacer PCB clip – Plug connector

15 POS.

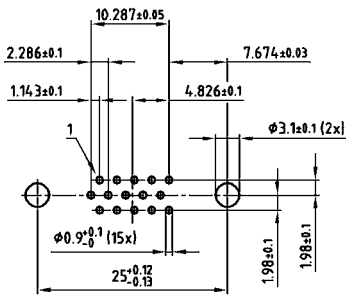

62 POS.

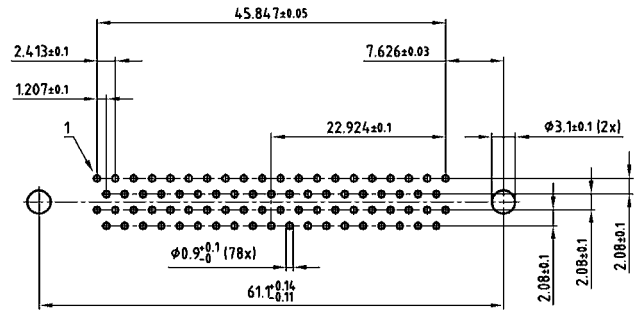

26 POS.

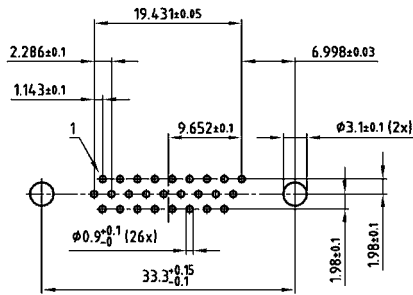

78 POS.

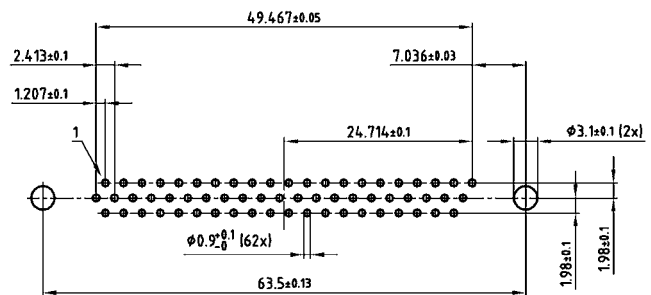

44 POS.

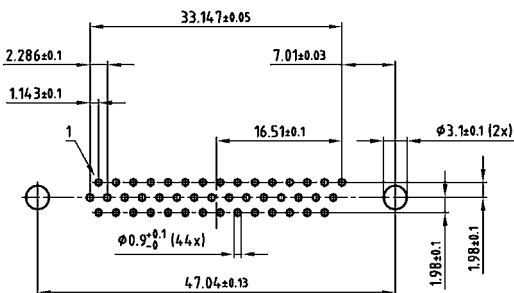

PCB layout Kat1iU0A (View: component side)

# PCB LAYOUT D-SUB HIGH DENSITY

Solder pin, angled, .220" / 5.6 mm – Plug connector

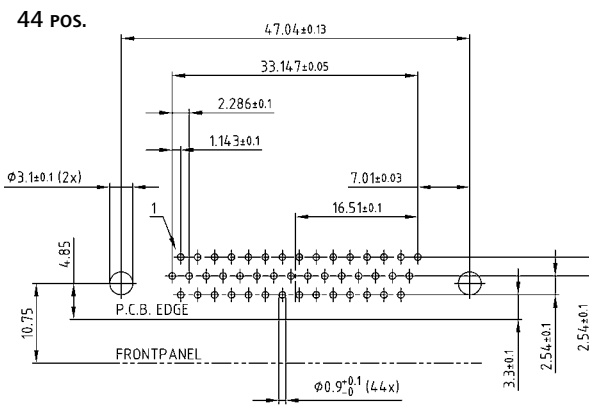
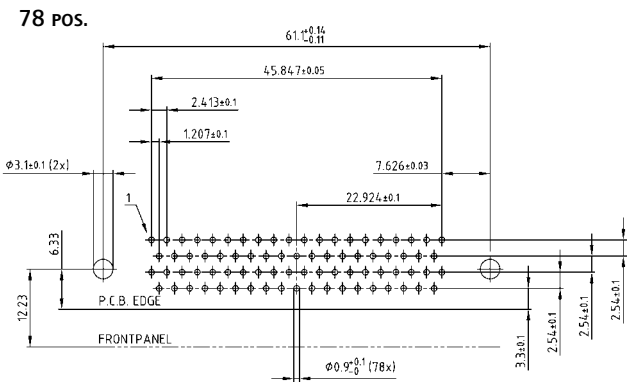
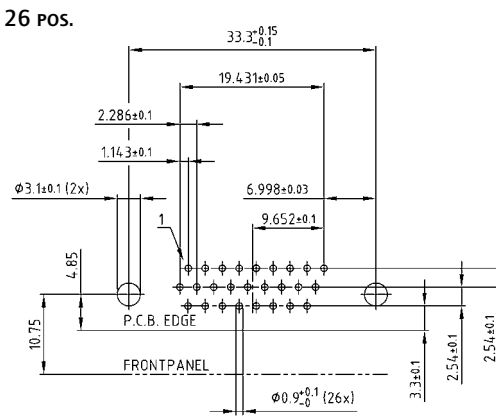
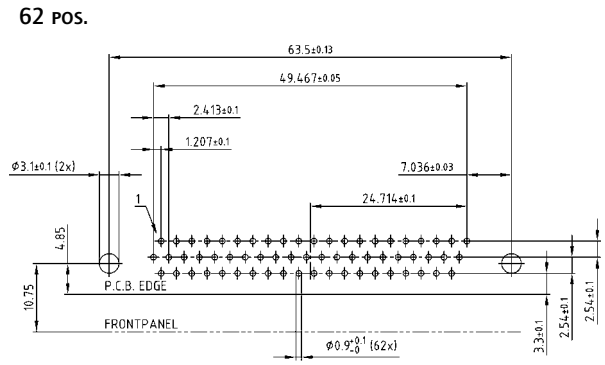
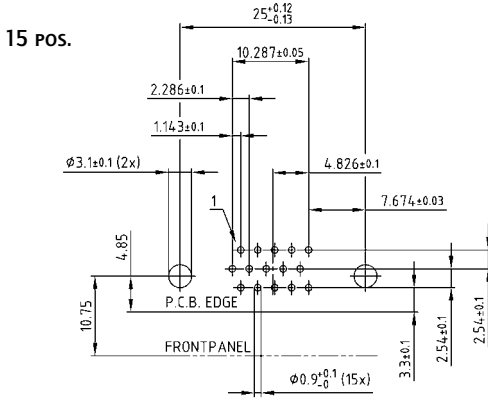

PCB layout Kat1 kgWA (View: component side)