

M12x1 CAN-BUS OVERMOULDED

Female connector axial

PVC violet

Contact assignment

Number of poles

Coding

Rated voltage [V]

Current rating [A]

Cable length = L [m]

Wire cross section [AWG]

Description

Part No.

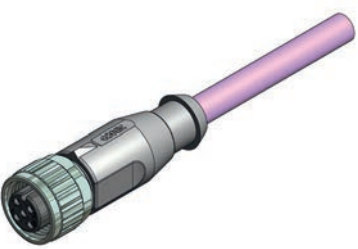
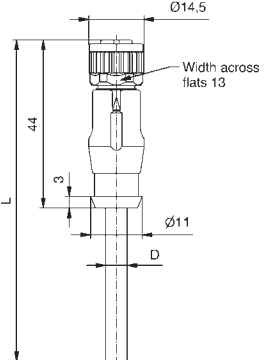
PVC violet		Contact assignment	Number of poles	Coding	Rated voltage [V]	Current rating [A]	Cable length = L [m]	Wire cross section [AWG]	Description	Part No.
  <p>Pin 1 ■ Pin 2 ■ Pin 3 ■ Pin 4 ■</p>	2	4	A	60	4	2 x 2 x 24	SAL-CN-12S-RK4.41-2/GU	43-14380		
	3						SAL-CN-12S-RK4.41-3/GU	43-14381		
	5						SAL-CN-12S-RK4.41-5/GU	43-14382		
	10						SAL-CN-12S-RK4.41-10/GU	43-14383		

Male connector axial

PVC violet

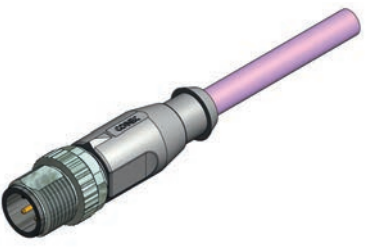
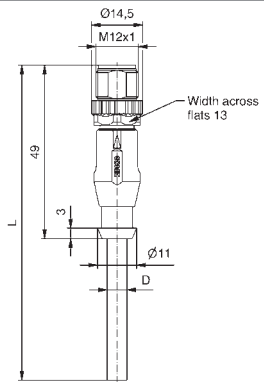
PVC violet		Contact assignment	Number of poles	Coding	Rated voltage [V]	Current rating [A]	Cable length = L [m]	Wire cross section [AWG]	Description	Part No.
  <p>Pin 1 ■ Pin 2 ■ Pin 3 ■ Pin 4 ■</p>	2	4	A	60	4	2 x 2 x 24	SAL-CN-12S-RS4.41-2/GU	43-14384		
	3						SAL-CN-12S-RS4.41-3/GU	43-14385		
	5						SAL-CN-12S-RS4.41-5/GU	43-14386		
	10						SAL-CN-12S-RS4.41-10/GU	43-14387		

M12x1 CAN-BUS OVERMOULDED

Connecting cable

Female connector axial

Male connector axial

PVC, UL, violet

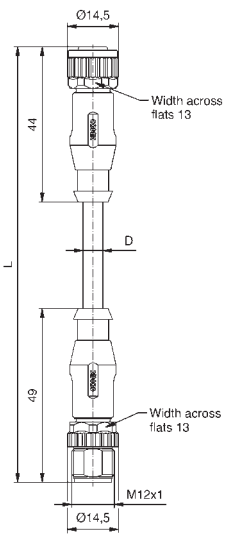
PVC, UL, violet		Contact assignment	Number of poles	Coding	Rated voltage [V]	Current rating [A]	Cable length = L [m]	Wire cross section [AWG]	Description	Part No.
  <p>Pin 1 ■ Pin 2 ■ Pin 3 ■ Pin 4 ■</p>	0,3	4	A	60	4	2 x 2 x 24	SAL-CN-12S-RK4.41-RS4.41-0,3/GU	43-14388		
	0,6						SAL-CN-12S-RK4.41-RS4.41-0,6/GU	43-14389		
	1,5						SAL-CN-12S-RK4.41-RS4.41-1,5/GU	43-14390		
	3						SAL-CN-12S-RK4.41-RS4.41-3/GU	43-14391		

M12x1 CAN-BUS OVERMOULDED SOCKETS

Front panel mounting, Wire termination

Female connector, M16x1.5 thread

Contact assignment

Number of poles	Coding	Rated voltage [V]	Current rating [A]	Wire material	Wire length = L [mm]	Wire cross section [AWG]
4	A	250	4	PVC	0,5	24

Description

Part No.

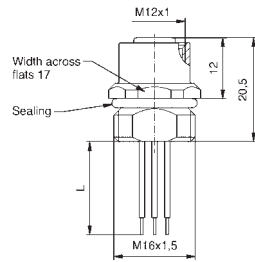
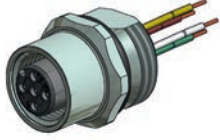

- Pin 1 ■
- Pin 2 ■
- Pin 3 ■
- Pin 4 ■

SAL-CN-12-FK4.41-0,5

43-01703

Male connector, M16x1.5 thread

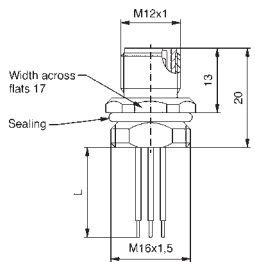
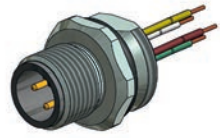

- Pin 1 ■
- Pin 2 ■
- Pin 3 ■
- Pin 4 ■

SAL-CN-12-FS4.41-0,5

43-01704

Back panel mounting, Wire termination

Female connector, M16x1.5 thread

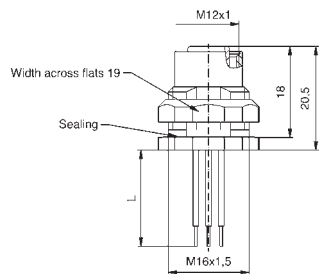
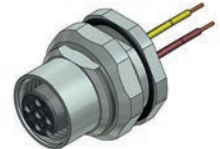

- Pin 1 ■
- Pin 2 ■
- Pin 3 ■
- Pin 4 ■

SAL-CN-12-FK4.41-0,5

43-02347

Male connector, M16x1.5 thread

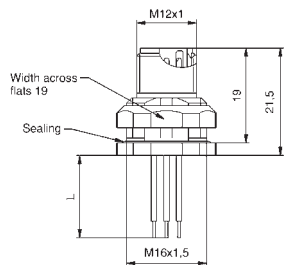
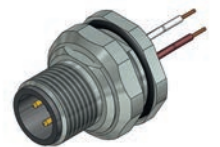

- Pin 1 ■
- Pin 2 ■
- Pin 3 ■
- Pin 4 ■

SAL-CN-12-FSH4.41-0,5

43-02348